

TABLE OF CONTENTS

EN

General information	2
Purpose of the manual.....	2
Identification of manufacturer and equipment.....	3
Safety information	3
Safety regulations.....	3
Safety signals.....	5
Technical information	6
Technical specifications.....	6
General description of the appliance.....	7
Main parts.....	8
Installation	9
Packing and unpacking.....	9
Planning and system installation.....	9
Preparation and marking the boundaries of the work areas.....	10
Slopes.....	13
Steep slopes.....	13
Possible elements inside the work area and relative safety distances.....	14
Adjustments	15
Adjustment recommendations.....	15
Adjustment of cutting height.....	15
Use and functioning without the automatic recharge station kit	16
Requirements for use.....	16
Description of control panel and menu overview.....	16
Meaning of led combinations.....	17
Start-up.....	17
Start-up via app.....	18
Actuation with scheduled/delayed departure.....	18
Robot safety stop.....	19
Robot stop.....	19
Planning and installation of the automatic recharge station kit.....	20
Installation of guide wire.....	26
Battery charging on first use.....	27
Use and operation	28
Requirements for use.....	28
Description of control panel and menu overview.....	28
Actuation with the charging station kit.....	29
Use of the robot in closed areas with no charging station.....	30
Access to the menu via app.....	30
Setting the user menu via the mobile application.....	30
Menu settings - programming mode.....	31
Configuring the “connect module”.....	33
Prolonged inactivity and restarting.....	34
Battery charging after prolonged inactivity.....	35
Operating tips.....	36
Routine maintenance	36
Maintenance recommendations.....	36
Scheduled maintenance table.....	36
Robot cleaning.....	37
Troubleshooting.....	38
Troubleshooting guide	38
Part replacement	40
Recommendations for replacing parts.....	40
Battery replacement.....	40
Blade replacement.....	40
Robot disposal.....	41
Ec declaration of conformity	42
Warranty rules	43
Conditions and limitations.....	43
How to request warranty service.....	43
Additional definitions.....	43

Reproduction, even partial, of this document without written permission by the manufacturer is strictly forbidden. The manufacturer assumes a policy of continual improvement and reserves the right to modify this document without prior notice on condition that the changes do not constitute health and safety risks.
© 2008 – Text, illustrations and page layout by Tipolito La Zecca. The text may be reproduced, in whole or in part, on condition that the author is mentioned.

PURPOSE OF THE MANUAL

- This manual forms an integral part of the appliance and was produced by the Manufacturer to provide the necessary information to people authorised to interact with it during its working life.
- Operators of the appliance must adopt correct working practices and must carefully read and follow all the instructions contained in this manual.
- This information is original and supplied by the manufacturer.
- Carefully read the instructions contained in this manual to avoid any unnecessary risks to people's health and safety, as well as economic damages.
- Keep this manual in a safe and easily accessible place for quick reference.
- Some information and illustrations contained in this manual may not perfectly correspond with the appliance in your possession; however, this does not affect its functioning.
- The Manufacturer reserves the right to make changes without any obligation to provide prior notice.
- The following symbols are used throughout this manual to highlight some particularly important information or to identify some important specifications.



Danger - Attention

This symbol indicates situations involving imminent danger, which, if ignored, could put people's health and safety at risk.



Warning – Caution

This symbol indicates situations where it is necessary to behave in a certain way in order to avoid putting people's health and safety at risk, and to protect the device.



Important

This symbol identifies particularly important technical information which must not be ignored.

IDENTIFICATION OF MANUFACTURER AND EQUIPMENT

The nameplate shown here is applied directly onto the appliance. It contains references and all the information essential for safely operating the device.

For any technical requirements, please contact the Manufacturer's Technical Service Centre or an authorised dealer.

For technical assistance, please indicate the data reported on the identification plate, the approximate hours of use and the type of fault detected.

- A. Name of manufacturer.
- B. CE conformity label.
- C. Model and Version / serial number / manufacturing year.
- D. Technical data: voltage, current, protection rating, mass, cutting width.

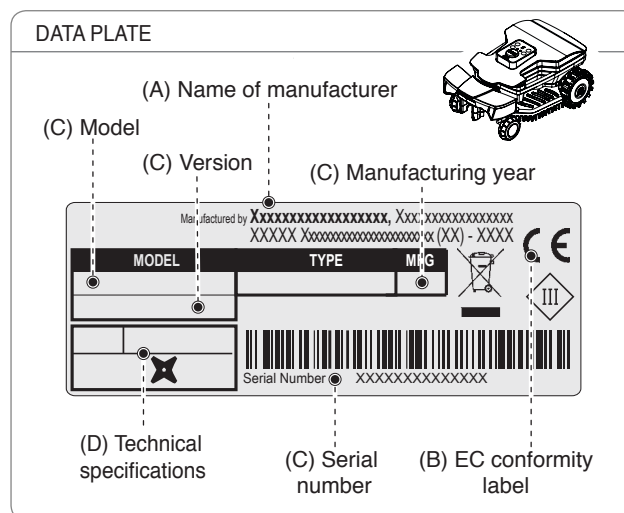

SAFETY INFORMATION

The manufacturer carefully considered the possible hazards and personal risks that may result from interacting with the equipment. The purpose of this information is to inform users on the need to use extreme caution in order to avoid risks.



SAFETY REGULATIONS













THIS PRODUCT COMES WITH A BLADE AND IS NOT A TOY!

- Please read the manual carefully, especially the safety instructions, and make sure you understand them fully before using the product. Only use the equipment for the purposes specifically intended by the manufacturer. Carefully follow the instructions on operation, maintenance and repair.
- When using the robot, make sure there is no one in the working area, in particular children, the elderly or disabled and pets. Otherwise, program the robot to operate during hours when there is no one in this area. Keep an eye on the robot if you know that pets, children or other people are in the area. If a person or animal is found on the robot's path, stop it immediately.
- In working areas not bounded by a fence that can not be easily climbed over, supervise the device during the operation.
- Warning signs shall be placed around the working area of the robotic lawnmower if it is used in public areas. The signs shall have the following text: "**Warning! Automatic lawnmower! Keep away from the machine! Supervise children!**"
- This robot is not suitable for use by children and people with reduced physical, sensory or mental capabilities or inexperienced people who are not familiar with the product, unless they are supervised by a person responsible for their safety or have received instructions on how to use the appliance. Children should be supervised to ensure that they do not play with the appliance.
- Do not allow the robot to be used by people who do not know how it works.
- Operators who perform maintenance and repair work must be fully conversant with its special features and safety regulations. Before using the robot, carefully read the operating manual and make sure you understand the instructions.
- Never remove, bypass or tamper with the safety devices installed. The Manufacturer shall not be held liable if non-original spare parts are used. Failure to comply with this requirement may seriously endanger the health and safety of people.

- Check that there are no toys, tools, branches, clothing or other objects on the lawn which can damage the blades. Any objects on the lawn can also damage or prevent the correct functioning of the robot.
- Never allow people to sit on the robot. Never lift the robot to inspect the blade or to carry it while it is running. Do not place hands and feet under the robot when it is in operation.
- Do not use the robot when a sprinkler system is running. In this case, program the robot and the sprinkler system so that they do not operate at the same time. Do not wash the robot with high-pressure water jets and do not immerse it in water, partially or completely, as it is not watertight.
- Disconnect the power supply and activate the safety device before performing any adjustment or maintenance that the user is authorised to perform. Use the personal protection devices recommended by the Manufacturer, in particular, always wear protective gloves when handling the cutting blade.
- Cleaning and maintenance must not be performed by unsupervised children.
- Do not use the robot when the cutting blade is damaged. Replace the cutting blade.
- Do not use the robot with damaged external parts. If the mechanical parts of the robot are damaged, replace them.
- Do not use the robot if the power cord of the transformer is damaged. A damaged cord can lead to contact with live parts. To avoid any risk, have the cord replaced by the manufacturer or by its technical service centre or by a person with similar qualifications.
- If the power cord is damaged during use, press “STOP” to stop the robot and disconnect the power cord from the electrical socket.
- Visually check the robot regularly to make sure the blade, mounting screws and cutting mechanism are not worn or damaged. Make sure that all the nuts, bolts and screws are tightened to ensure that the robot is in good working condition.
- If the robot starts to vibrate abnormally during use, press “STOP” and disconnect the power cord from the electrical socket.
- Never use and recharge the robot in explosive and/or flammable environments.
- Only use the battery charger and power supply unit supplied by the manufacturer. Improper use may cause electric shocks, overheating or leakage of corrosive liquids from the battery. If any liquid leaks, wash the battery with water/neutraliser; in case of contact with eyes, seek medical attention.

SAFETY SIGNALS

	<p>Read user instructions carefully to understand meanings before using the machine.</p>		<p>Keep an adequate safe distance from the machine while it is running.</p> <p>While the robot is working, make sure there are no people in the working area (especially children, elderly or disabled people) and pets. Keep children, pets and other people at a safe distance when the machine is functioning. To prevent that risk, we advise scheduling the robot's mowing activities at suitable times.</p>
	<p>Do not touch the rotary blade and do not place your hands or feet underneath the machine when it is running. Wait until the blade and rotating parts come to a complete stop before accessing.</p>		<p>Warning! Do not spray water on the machine to clean or wash it.</p> <p>While the robot is working, make sure there are no people in the working area (especially children, elderly or disabled people) and pets. Keep children, pets and other people at a safe distance when the machine is functioning. To prevent that risk, we advise scheduling the robot's mowing activities at suitable times.</p>
	<p>Do not ride on the machine.</p>		 <p>Operate the safety device before working on or lifting the machine.</p>
	<p>Operate the safety device before working on or lifting the machine.</p>		 <p>Use the robot only with the power supplies indicated in the "Technical Data" of the "Technical Information" chapter.</p>

TECHNICAL INFORMATION

TECHNICAL SPECIFICATIONS

Description		Model		
		B015DEZ		B020DEZ
AUTOMATIC RECHARGE STATION KIT		Optional	Yes	Yes
Maximum recommended surface that can be mowed				
Working capacity (-20%(*))	m ² (ft ²)	400 (4300')	800 (8611')	1000 (10763')
Features				
Dimensions (W x H x D)	mm	453x296x220		
Robot weight (incl. battery)	kg	7,5		
Cutting height (Min-Max)	mm (")	25-70 (0,98-2,75")		
Diameter of blade	mm (")	180 (7,08 ")		
Cutting blade speed	RPM	4200		
Ground speed	Metres / Minute	28 (91,8 ')		
Maximum recommended slope managed (*)	%	45% allowable, based on the lawn conditions and accessories installed. 35% maximum managed and recommended in conditions of a trimmed lawn. 20% in proximity of the outside edge or wire.		
Ambient operating temperature	Max °C	ROBOT: -10°(14 F.) (Min) +50° (122 F.) (Max) BATTERY CHARGER: -10°(14 F.) (Min) +40° (104 F.) (Max)	CHARGING STATION: -10°(14 F.) (Min) +45° (113 F.) (Max)	ROBOT: -10°(14 F.) (Min) +50° (122 F.) (Max) BATTERY CHARGER: -10°(14 F.) (Min) +40° (104 F.) (Max) CHARGING STATION: -10°(14 F.) (Min) +45°(113 F.) (Max)
Measured sound power level	dB(A)	59		
Water protection class	IP	ROBOT: IPx5 BATTERY CHARGER: IPx4	CHARGING STATION: IPx4	ROBOT: IPx5 BATTERY CHARGER: IPx4 CHARGING STATION: IPx4
Electrical features				
Power supply unit (for lithium battery)		SOY-2940230 Input: 100-240 V~; 1.8A; 50/60Hz; Class 1 Output: 29.4V ; ===; 2.3A - Alternative code - Mean Well OWA-60E-30ZCT Input: 100-240 V~; 1.2A; 50/60 Hz; Class 2 Output: 29.4V === ; 2.0A		
Type of accumulator and charging batteries				
Rechargeable Lithium-Ion Battery (rated voltage)		25.9V - 5.0 Ah		
Average recharging time	hh:mm	2:30	2:00	2:00
Average mowing duration after a full charge cycle (*)	hh:mm	03:00	04:00	04:00

(*) Depends on the condition of the grass, lawn and the complexity of the mowing area.

Frequencies				
Transmitter for the robot driving			Frequency band of work (Hz) 500 - 60000 maximum radio frequency power (dBm) < 10	
Bluetooth			Frequency band of work (MHz) 2402 - 2480 maximum radio frequency power (dBm) < 14	
GSM			Frequency band of work (MHz) 850/900/1800/1900 maximum radio frequency power (dBm) < 33	
Equipment / Accessories / Functions				
Areas managed, including the primary zone		1	4	4
Rain sensor			Standard	
Eco Mode -Self-programming (patented)			Standard	
Connect module (GPS, GPRS)			Optional	
Re-entry method to the charging station		-	"V-Meter"- "follow wire"	"V-Meter"- "follow wire"
Maximum length of wire (approximate, calculated based on a regular perimeter)	m (')	-	600 (1968')	600 (1968')

(*) Depends on the condition of the grass, lawn and the complexity of the mowing area.

GENERAL DESCRIPTION OF THE APPLIANCE

The appliance is a robot designed and built to automatically trim grass in gardens and house lawns at any time of the day or night. It is small, compact, silent and easy to transport.

During operation, the robot mows the area delimited by paving and/or barriers (fences, walls, etc.).

When the robot detects that there is no grass or encounters an obstacle, it changes route in a random manner and starts mowing again in a new direction.

According to its operating principle random, the robot automatically trims the entire delimited area of the lawn (see figure).

The robot is able to recognise the presence of higher and/or thicker grass in an area of the garden and to automatically activate, if considered necessary, the spiral movement for a perfect finish.

The lawn surface that the robot is able to trim depends on a series of factors, such as:

- model of the robot and type of batteries installed;
- characteristics of the area (irregular perimeters, uneven surfaces, divided areas, etc.);
- characteristics of the lawn (type and height of the grass, moisture, etc.);
- conditions of the blade (level of sharpness, without residuals and deposits, etc.);

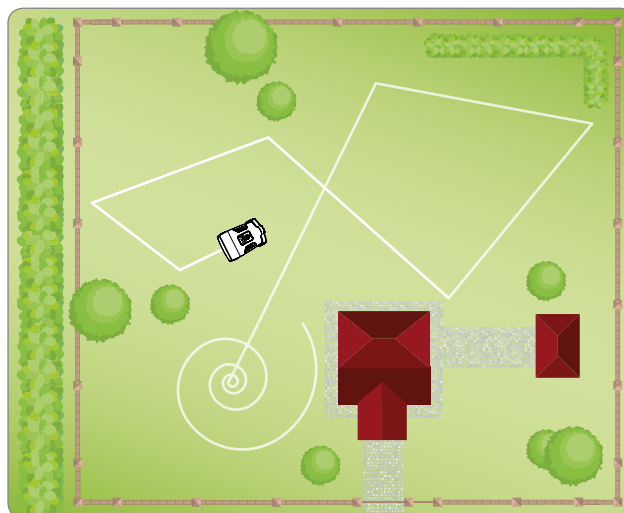

MAIN PARTS

EN

MODEL		B015DEZ	B020DEZ
Version		A	A
①	Robot	✓	✓
②	Keyboard commands	✓	✓
③	Rain sensor	✓	✓
④	Battery	✓	✓
⑤	Handle	✓	✓
⑥	Cutting blade	✓	✓
⑦	Power Supply unit	✓	✓
⑧	User manual	✓	✓
⑨	Key for adjusting the cutting height	✓	✓
	KIT ⑩ ⑪ ⑫ ⑬ ⑭	Optional	✓



Important

In some model configuration the Automatic Charging Station Kit can be sold as an optional.

AUTOMATIC RECHARGE STATION KIT

⑩	Wire coil	50m
⑪	Pegs	40
⑫	Charging station	✓
⑬	Transmitter	✓
⑭	Joint for wire	Optional

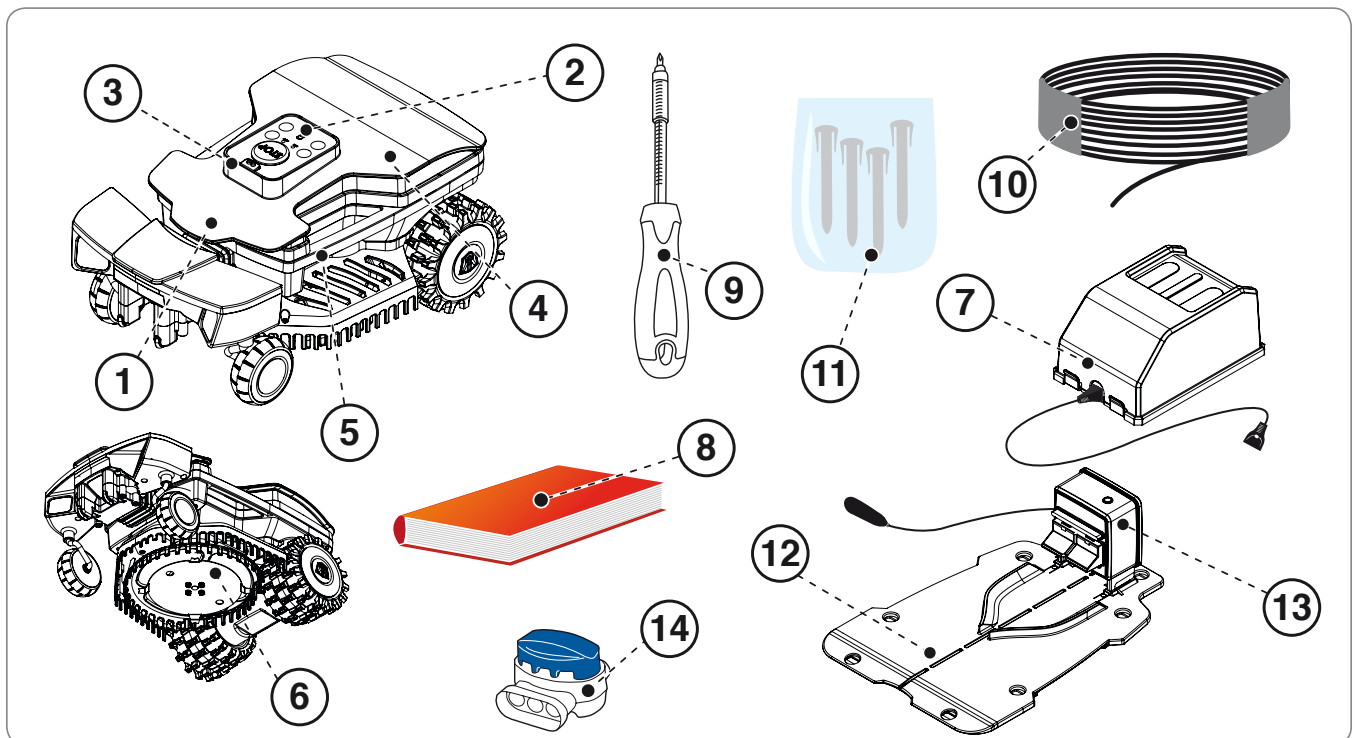

PACKING AND UNPACKING

The equipment is delivered suitably packaged. When unpacking, carefully remove and check the integrity of the parts.



Warning – Caution

Keep plastic wrapping and plastic containers away from infants and children: risk of suffocation!



Important

Keep the packaging materials for future use.

PLANNING AND SYSTEM INSTALLATION

The robot is not difficult to install, but requires some preliminary planning in order to define the best area for installing the power supply unit.

Position the power supply unit in an easy to access zone.

- The power supply unit must be in a well-ventilated area, protected from direct sunlight and exposure to the elements.
- The power supply unit must not be in direct contact with the ground or humid environments.



Warning – Caution

Position the power supply unit in an area that cannot be reached by children.

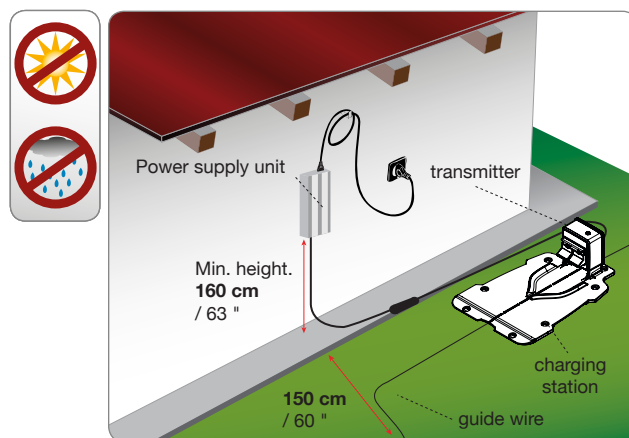

Warning – Caution

When connecting the electricity, it is necessary that a power outlet is positioned near the installation area. Make sure the connection to the mains power complies with the applicable laws. To operate in complete safety, make sure the electrical system, which is connected to the power supply unit, is equipped with a well-functioning earthing system. The supply circuit shall be protected by a residual current device (RCD) with a tripping current of not more than 30 mA.



Warning – Caution

Make sure only authorised people have access to the power supply.

PREPARATION AND MARKING THE BOUNDARIES OF THE WORK AREAS

preparation of the lawn to be mowed

1. Make sure that the lawn to mow is even and does not contain holes, stones or other obstacles. Otherwise, prepare the lawn by filling in any holes and removing any obstacles. If some obstacles cannot be removed, it is necessary to properly define and protect the interested areas.
2. Check that all the areas of the lawn do not exceed the allowable slopes (see "Technical Specifications").

The sensors, which recognise the presence of the grassy surface, allow the robot to move freely inside the lawn. The lawn must be suitably checked and adjusted so that the robot has enough space for recognising when there is no grass. Carefully follow the below points for the correct and safe use of the robot.

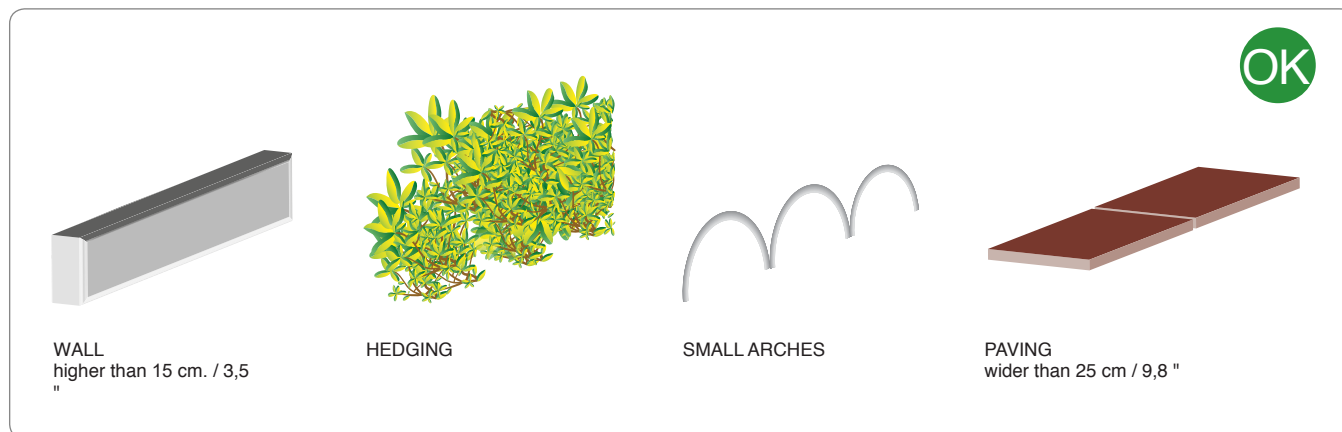

Types of boundaries/protections that can be used for correctly defining the limits of the robot's work area.

Pavement

The robot needs at least 25cm of free flat surface to stop safely and change direction.

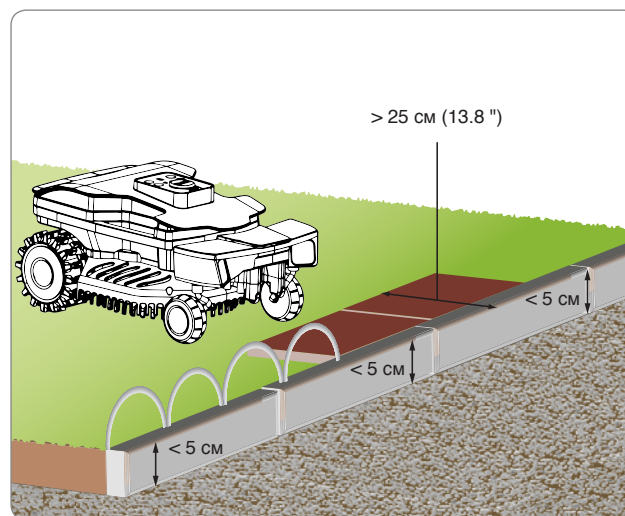

Wall

Perimeter wall, which defines the boundary of the work area at a height above 15 cm. (3.54 "). If the walls are shorter, protect the area with arches or adequate paving.

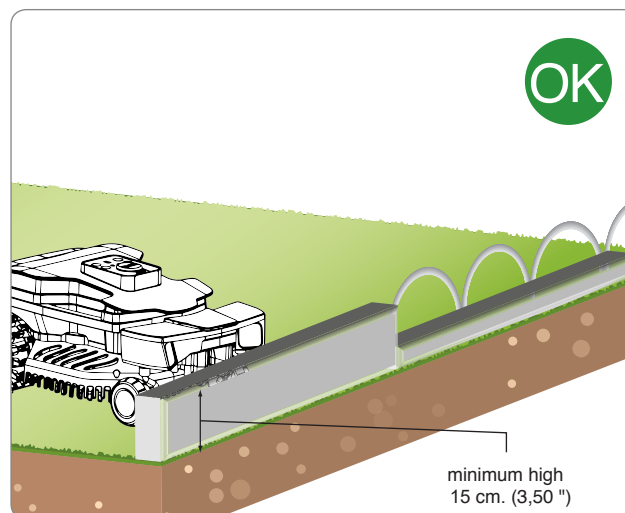

Hedging

The work area can also be effectively delimited by hedges.

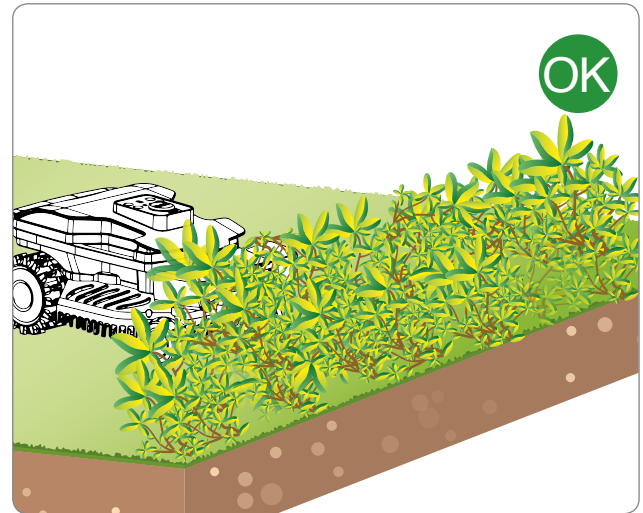

Holes

The work area cannot be delimited by ditches or holes which must not be present inside the grassy area to mow. Before starting the robot, check that there are no objects on the lawn such as toys, small stones, branches or sprinklers protruding from the ground which could impede correct functioning or cause damage to the blade.

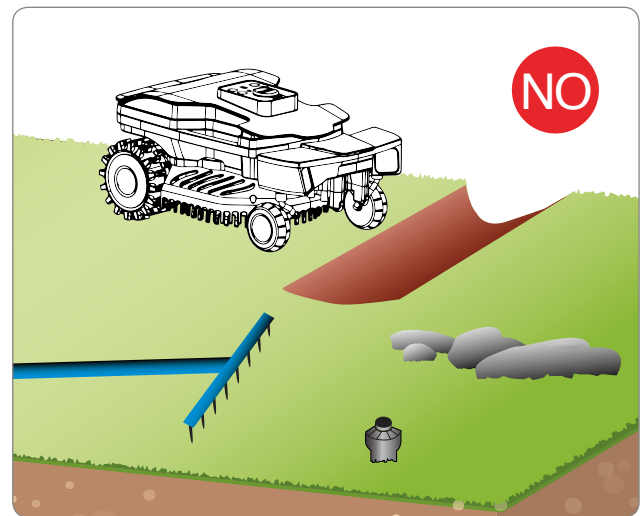

Obstacles and protections

The illustrations show an example of the internal and peripheral elements of the correct work area. If elements such as tree roots or exposed wires are present, it is necessary to delimit the perimeter of these elements with paving, walls or barriers to prevent the malfunctioning of the robot. Elements (trees, poles, etc. ref. fig. obstacles) which do not impede the robot's normal functioning do not require delimiting.



Roots

Do not, under any circumstance, leave areas which have not been delimited by barriers inside the work area, as these will prevent the robot from functioning properly (roots, external pipes, work tools, etc.).



Fine gravel



Danger - Attention

The presence of leaves on the lawn may cause the robot not to recognize the grass. Protect the area with boundaries.

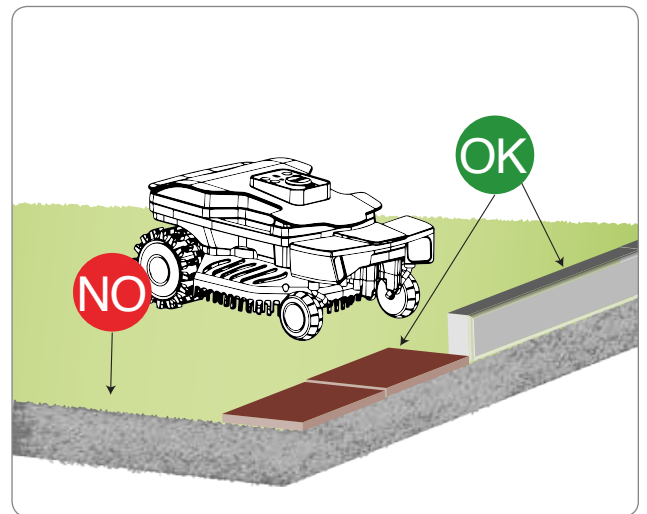

Sharp corners



Danger - Attention

In areas of the lawn that end in narrow spaces as shown in the figure, the robot cannot move easily, therefore this part of the lawn must be excluded because the robot would exit the borders.

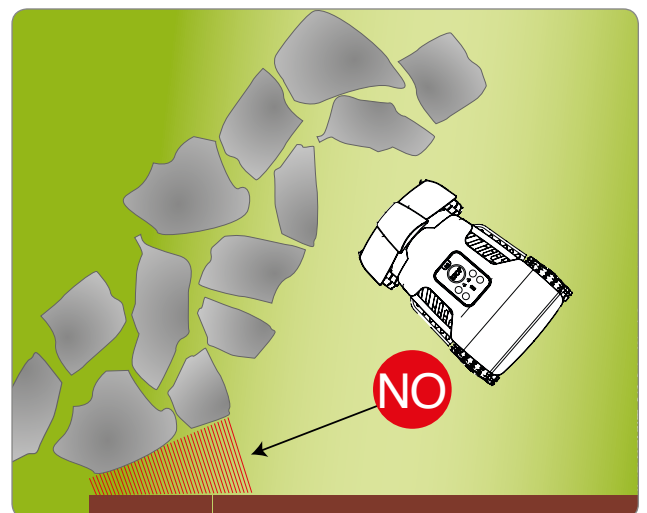

SLOPES

Check that all the areas of the lawn do not exceed the admissible slopes (see "Technical Specifications"). Areas with steeper slopes or that are incompatible with the correct functioning of the robot (see following points) cannot be mowed. Steeper slopes must be delimited.



Important

The sensors of the robot can detect slopes greater than the robot can manage. The direction is reversed in order to prevent the robot from tipping over or malfunctioning. In addition, as a further protection, it is necessary to delimit the areas, which have slopes that cannot be managed. It is recommended to test the robot when using for the first time on slopes that are at the limit of the specifications.

UPWARD SLOPE

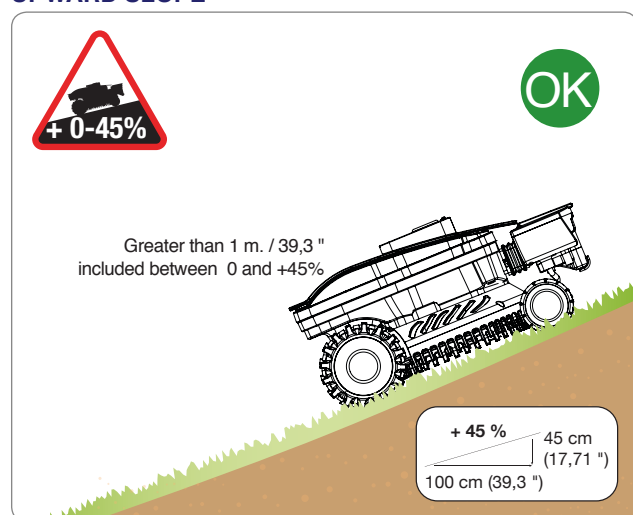

DOWNWARD SLOPE

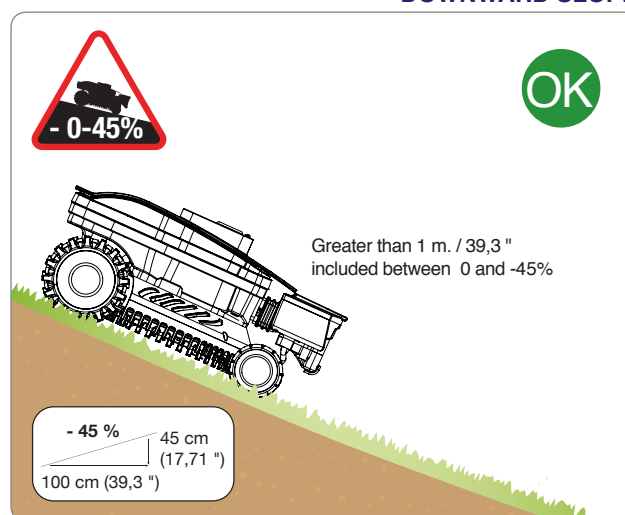

The robot can tackle height differences with a slope of up to 45% provided that they gradually slope down over a distance of more than one metre.

STEEP SLOPES

The robot's safety system will interpret sudden changes in the slope (greater than 25%) as an anomaly and therefore, will reverse the direction and bring the robot back to safety continuing to mow the lawn. Tree trunks which gradually rise from the ground or stones positioned to mark the boundary of flower-strips which gently descend onto the grassy surface are also interpreted as slope changes.



Important

Check the robot when using for the first time on slopes that are at the limit of the specifications.

UPWARD SLOPE

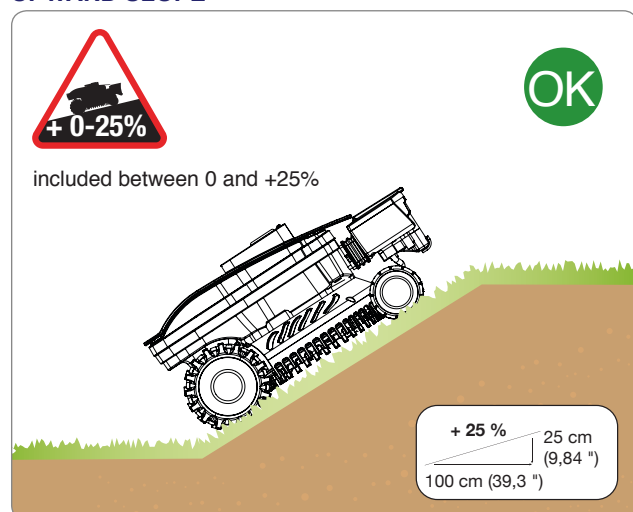

DOWNWARD SLOPE

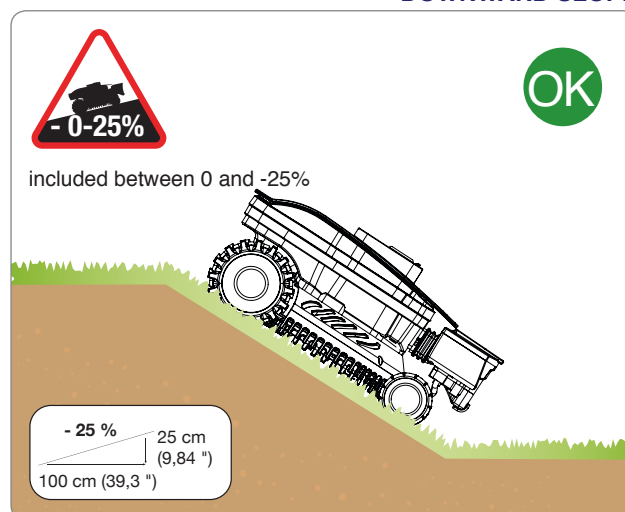

The robot can tackle height differences with slopes of up to 25% if they slope down suddenly.



Important

Areas with slopes greater than those specified cannot be mowed with the robot.

EN

POSSIBLE ELEMENTS INSIDE THE WORK AREA AND RELATIVE SAFETY DISTANCES

APPROPRIATE POOL PREPARATION

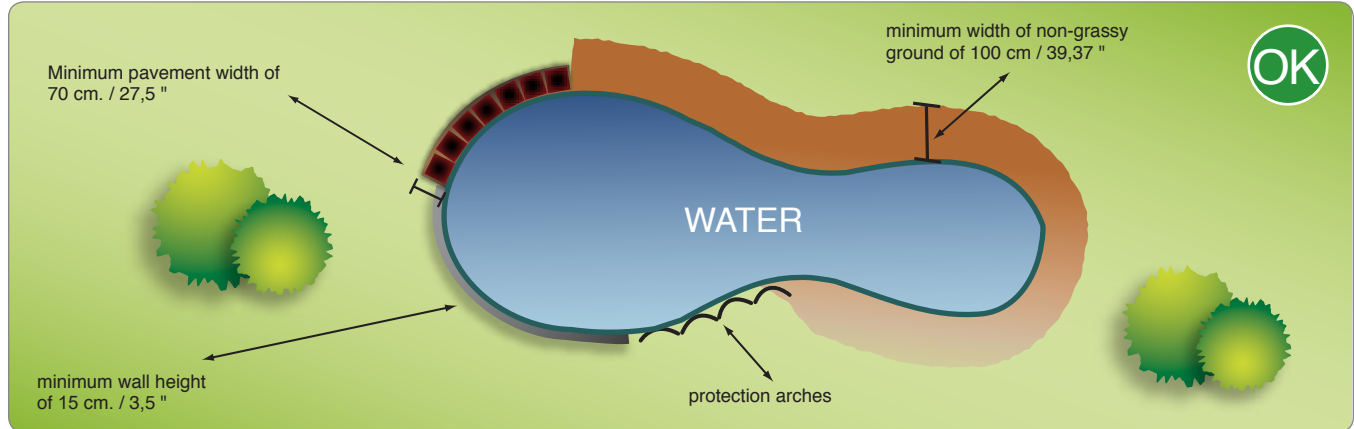

The figure above shows a work area which has been correctly delimited for the correct functioning of the robot.

INAPPROPRIATE POOL PREPARATION

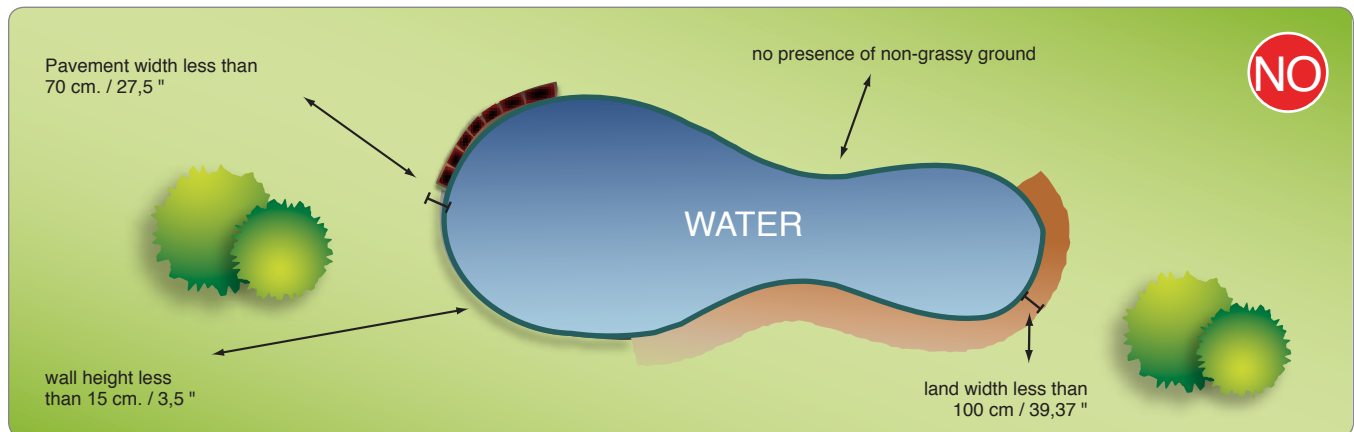

The figure above shows a work area where the robot's operating areas have not been correctly delimited, thus preventing it from functioning properly.

**Important**

The user must make any adjustments according to the procedures described in this manual. Do not make any adjustments which are not expressly indicated in this manual. Any special adjustments, not expressly indicated in this manual, must only be performed by personnel from the Manufacturer's authorised service centre.

ADJUSTMENT OF CUTTING HEIGHT

Before setting the cutting height of the blade, make sure the robot is safely off (see "Robot Safety Stop").

**Important**

Use protective gloves to prevent injuries to your hands.

1. Turn over the robot and position it so as not to ruin the hood.
2. Turn the bracket (E) in a clockwise direction with the key provided.
3. Lift or lower the cutting unit (D) to set the desired cutting height. The value can be measured using the graduated scale found on the key provided.

**Important**

Do not use the robot to mow grass which is 1 cm (0.40 ") higher than the cutting blade. Reduce the cutting height gradually. It is recommended to reduce the height by at least 1 cm (0.40 ") every 1-2 days until the ideal height is reached.

4. Once the adjustment has been made, turn the bracket (E) in a counter-clockwise direction.
5. Turn the robot back over to its operating position.

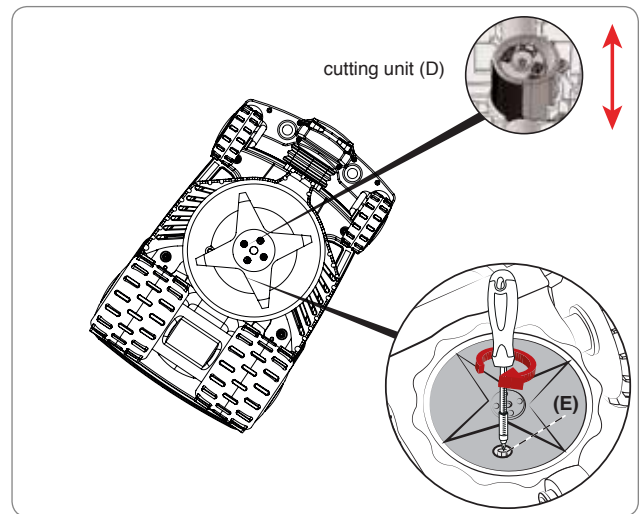

REQUIREMENTS FOR USE

EN



Important

- When using the robot for the first time, carefully read the entire manual and be sure to fully understand it, especially the safety recommendations.
- Only use the robot for its intended purpose as described by the Manufacturer and do not tamper with any device to obtain different operating performances.
- Do not use the robot and its peripheral units in bad weather conditions, especially when there is a risk of lightning.

DESCRIPTION OF CONTROL PANEL AND MENU OVERVIEW

The illustration shows the location and function of the controls on the machine.



STOP.

Press to stop the robotic mower safely. Only use in case of imminent danger and to perform maintenance on the robot.



Press to turn the robot on and off.



To enable or disable the programmed start (settable from the App).

When pressed, the start is delayed by 1 hour every 3 seconds of pressing (the robot makes a sound for each hour of delay set).



Off: programmed start function disabled
Steady on: programmed start function enabled
Flashing: the number of flashes indicates how many hours of delay have been set.



Battery charge level.



Operating errors. Refer to the chapter "TROUBLESHOOTING"



Press to start a manual work cycle. If the battery is sufficiently charged and the AUTO LED is off, the robot starts a work cycle.





Not used in the absence of the automatic charging station kit.



MEANING OF LED COMBINATIONS

IN OPERATION ROBOT

- A. BATTERY:**
-  The robot is on/working
 -  Low battery level
 -  Slow flash: stand-by mode. waiting for the set/delayed cycle to start.

- C. ALERT:** Refer to the "TROUBLESHOOTING" chapter for a detailed explanation on how to fix the problem.

RECHARGING ROBOT

- A. BATTERY:**
-  Charging completed.
 -  Charging.

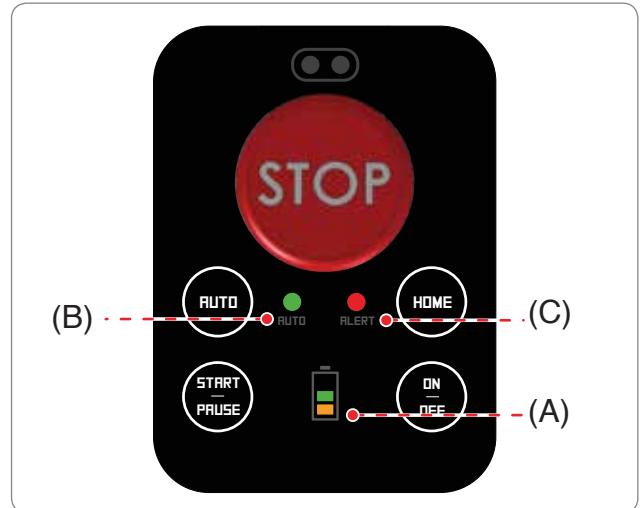

START-UP

1. Check that the grassy surface of the lawn to mow is at a height which is compatible with the proper functioning of the robot (see technical specifications).
2. Adjust the desired cutting height (see cutting height adjustment).
3. Check that the work area is correctly delimited and that there are no impediments to the correct functioning of the robot as indicated in the section "Preparation and defining the boundaries of the work areas" and following sections.
4. Place the robot on the charging station.
5. Once connected, the robot turns on automatically and displays the battery charge level (see "meaning of led combination").
6. At the end of charging, disconnect the robot and press the "ON/OFF" button. On first use, always charge the batteries for at least 4 hours.
7. Position the robot inside the grassy surface in an area where the grass is at least 1 metre (40.00 ") from any obstacle.
8. Press the "OFF/ON" key and wait a few seconds for the robot to turn on completely.
9. Press "START/PAUSE" key to start the robot.

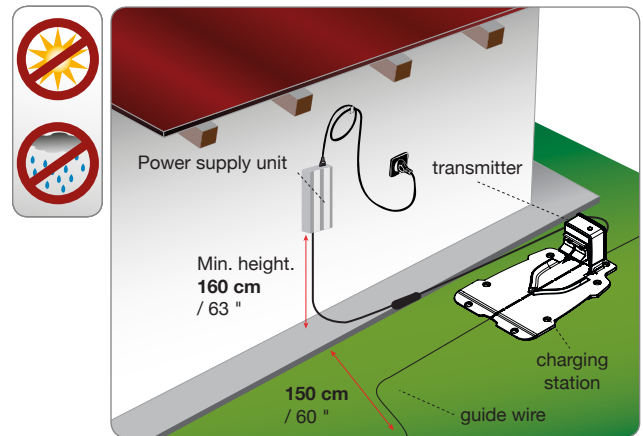

Once the robot has stopped because of the reasons listed in the chapter "Robot stopping", reposition the robot in the area of the charging station.



Important

For better quality of the cut, do not start the robot in rainy weather. The best result are obtained during the central hours of the day.

START-UP VIA APP

The robot has a built-in Bluetooth device that allows it to be programmed and controlled via a smartphone.

Download the application from Google Play or the Apple Store using your smartphone or tablet. Start the application and follow the wizard to pair the Robot to your device.

The factory set PIN is "0000." Change the PIN as soon as possible to make the robot safe.

The application allows you to:

- start and stop the robot;
- Set the configuration of the "AUTO" key to program the working time;
- guide the robot during the mowing cycle;
- change the status of the sensors;
- display the status, alarms and any errors.

ACTUATION WITH SCHEDULED/DELAYED DEPARTURE

If necessary, the robot can be turned on and started at a set time.

Only at the first use it is necessary to set the "AUTO" button via APP.

- Press the "ON/OFF" key
- Start the application from your smartphone to access the programming of the "AUTO" button.
- set the working time and save the configuration.
- exit the APP to start the robot via the keyboard or use the APP for the programmed start up.

To start the robot via the keyboard, press the "ON/OFF" key if the robot is off. Wait a few seconds for it to turn on completely.

Briefly press the "AUTO" button to activate the related configuration set.

By keeping the AUTO key pressed, the delayed start is activated: every 3 seconds of pressure the start is delayed by 1 hour the robot makes a sound for each hour of delay set.

The steady green "AUTO" LED indicates that the programmed start is enabled. It flashes if the delayed start is active; the number of flashes corresponds to the set delay hours.

Press the "START/PAUSE" key and the robot will go into standby mode before starting the work cycle at the set time.



Important

In case of errors, turn off the robot by keeping the "ON/OFF" button pressed, and resume the start-up sequence.

ROBOT SAFETY STOP

During use, it may be necessary to stop the robot. In normal conditions, the robot can be stopped with the "OFF" key. In case of danger or when performing any maintenance, it is necessary to stop the robot in safe conditions in order to prevent the blade from accidentally starting. Press the "STOP" key to stop the robot. Disconnect the power plug from the electrical outlet.



Important

The robot safety stop is necessary during maintenance and repairs (for example, blade replacement, cleaning operations, etc.).

To start, proceed as indicated:

- position the robot inside the cutting area;
- press the ON/OFF key and wait a few seconds for the robot to turn on completely.
- press the START/PAUSE key to start the work cycle.

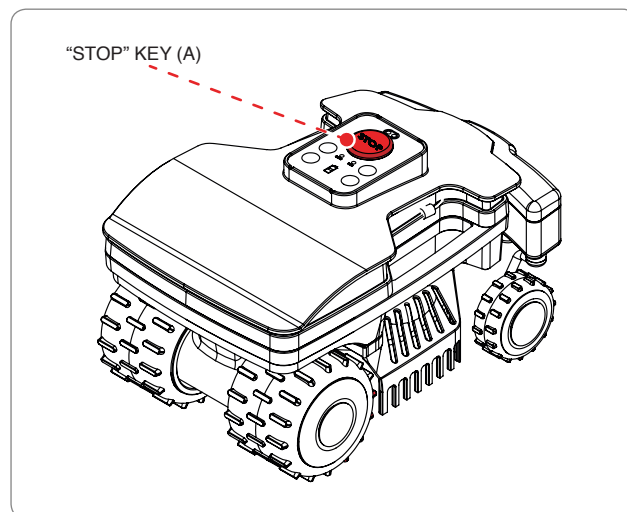

ROBOT STOP

the robot stops automatically if the following conditions are detected:

- **lawn mowed:** the sensor has detected that the lawn has been mowed and therefore, does not require further mowing. Recharge the batteries and start the robot again after one or two days based on the growth of the grass.
- **no grass present:** the grass sensors have not detected the presence of grass for an extended period. The alert LED shows two flashes.
- **discharged batteries:** the batteries have used up their operating capacity.

If the ALERT LED flashes, connect to the APP to see the error in detail.

PLANNING AND INSTALLATION OF THE AUTOMATIC RECHARGE STATION KIT

The robot is not difficult to install, but requires some preliminary planning in order to find the best area for installing the charging station, power supply unit and for laying out the guide wire.

- The charging station must be positioned on the edge of the lawn, preferably in the largest area from which other areas of the lawn are easily accessible. The area where the charging station is installed is hereinafter referred to as the "Primary Area."



Warning – Caution

Position the power supply unit in an area that cannot be reached by children. For example, at a height above 160 cm (63").



Warning – Caution

Make sure only authorised people have access to the power supply.



Warning – Caution

When connecting the electricity, it is necessary that a power outlet is positioned near the installation area. Make sure the connection to the mains power complies with the applicable laws. To operate in complete safety, make sure the electrical system, which is connected to the power supply unit, is equipped with a well-functioning earthing system. The supply circuit shall be protected by a residual current device (RCD) with a tripping current of not more than 30 mA.



Important

It is advisable to install the unit in a cabinet for electric components (for outdoor or indoor use), equipped with a key lock, and well-ventilated to maintain a correct air circulation.

- The robot must be able to easily find the charging station at the end of the work cycle, which will also be the starting point for a new work cycle and for reaching any other work areas, hereinafter referred to as "Secondary Areas."
- Position the charging station according to these rules:
 - on level ground;
 - on compact and stable ground with good drainage;
 - preferably in the widest part of the lawn;
 - in case of sprinklers, make sure the water jets are not directed inside the charging station;
 - make sure the entrance of the charging station is positioned as shown in the figure, so that the robot can enter it by following the guide wire in a clockwise direction;
 - there must be a straight area of 200 cm (78,74") in front of the charging station;
 - any metal bars or rails separating the lawn near the station may interfere with the signal. Position the station on a different side of the garden or at a safe distance from the metal barrier. For more information, please contact the Manufacturer's Technical Service Centre or an authorised dealer.
- The charging station must be well fastened to the ground. To prevent a small step from forming at the front of the charging station, position a small piece of fake grass at its entrance to stop this from occurring. Alternatively, remove part of the grassy surface and install the charging station flush with the grass.
- The charging station is connected to the power supply unit via a cord that must move away from the charging station on the outside of the cutting area.

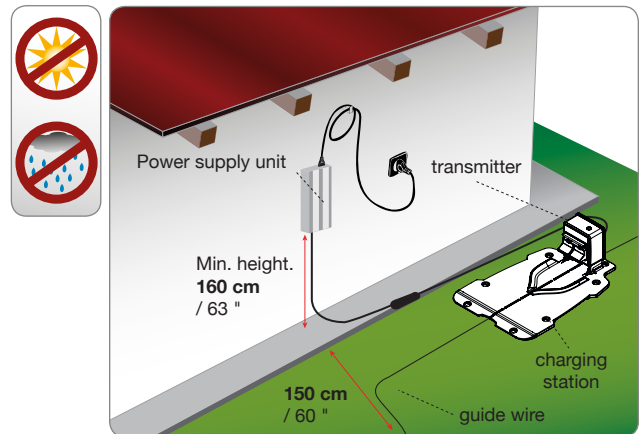

- Position the power supply unit according to these rules:
 - in a well-ventilated area protected against atmospheric agents and direct sunlight;
 - preferably inside your home, a garage or shed;
 - if positioned outdoors, the robot must not be exposed to direct sunlight and water. Therefore, it must be protected inside a ventilated box. Do not position in direct contact with the soil or humid environments;
 - position it on the outside of the lawn and not inside;
 - stretch out the excess cord going from the charging station to the power supply unit. Do not shorten or lengthen the cord.

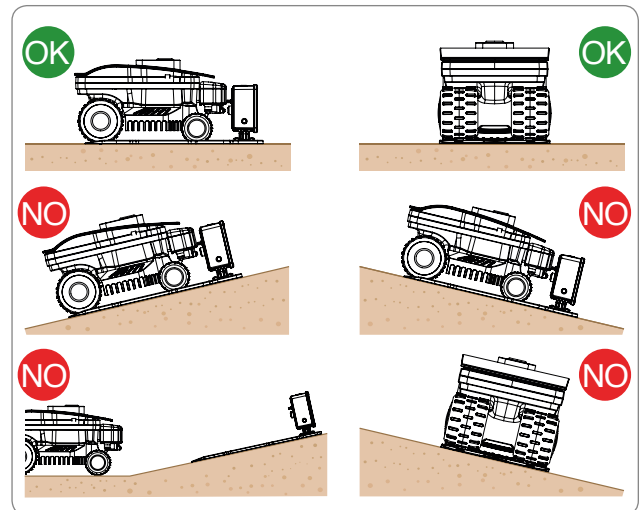

- The incoming section of the wire must be straight and aligned perpendicularly to the charging station by at least 200 cm (78.74 in.) and the outgoing section must move away from the charging station; this allows the correct re-entry of the robot.

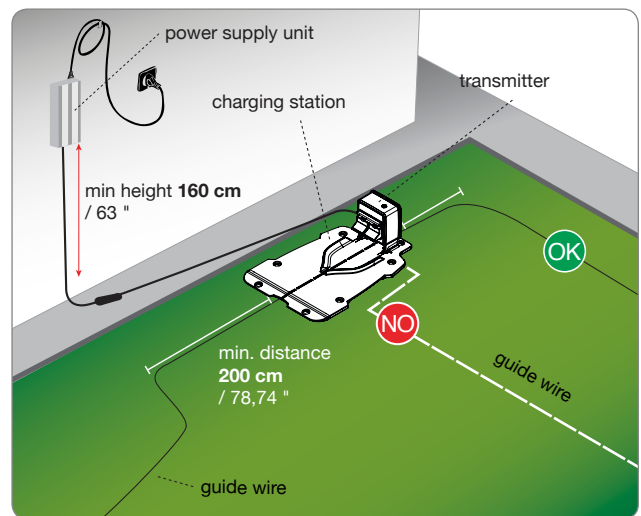

If the robot is installed near an area which has another robot (from the same or another manufacturer), then the transmitter and receiver of the robot must be modified during installation so that the frequencies of the two robots do not interfere with other. In this situation, contact the closest customer service centre.

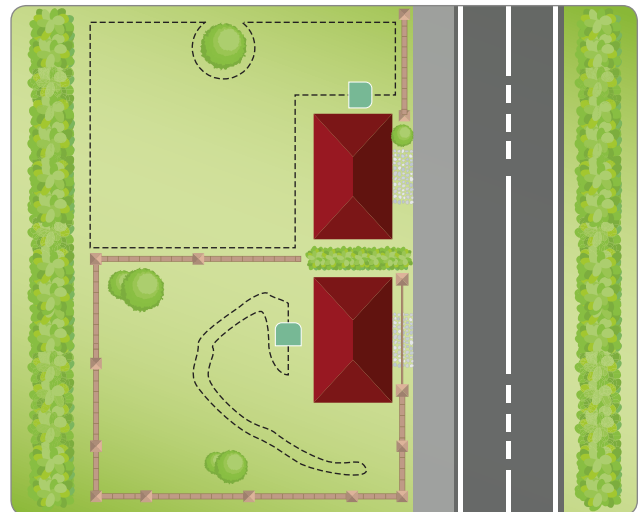

Installation of the charging station and power supply unit



Warning – Caution

Before carrying out any operations, disconnect the robot from the mains power.

Position the power supply unit in an area that cannot be reached by children. For example, at a height above 160 cm (63 ").

Do not shorten or lengthen the cable getting to the charging station, wrap as an 8 like form the excess cord, as shown in the figure.

The guide wire used for the installation cannot be less than 50m, contact the closest customer service centre .

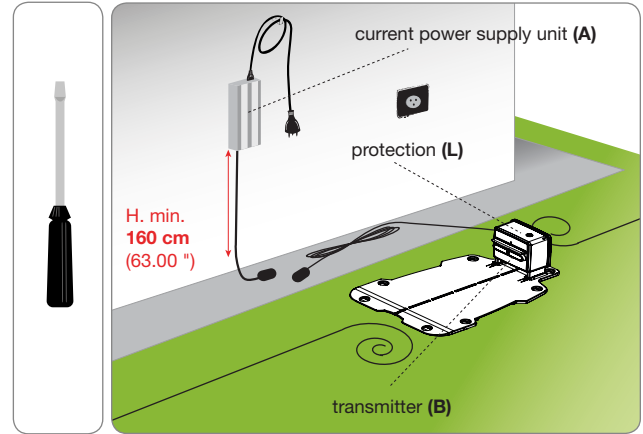

1. Position the charging station in the predefined area.
2. Insert the guide wire (M) along the guide in the charging station. Cut the excess guide wire to about 5cm above the connectors.
3. Connect the station incoming wire to red terminal of the transmitter (T). Connect the station outgoing wire to the black terminal.



The terminals are used only to connect the original guide wire.

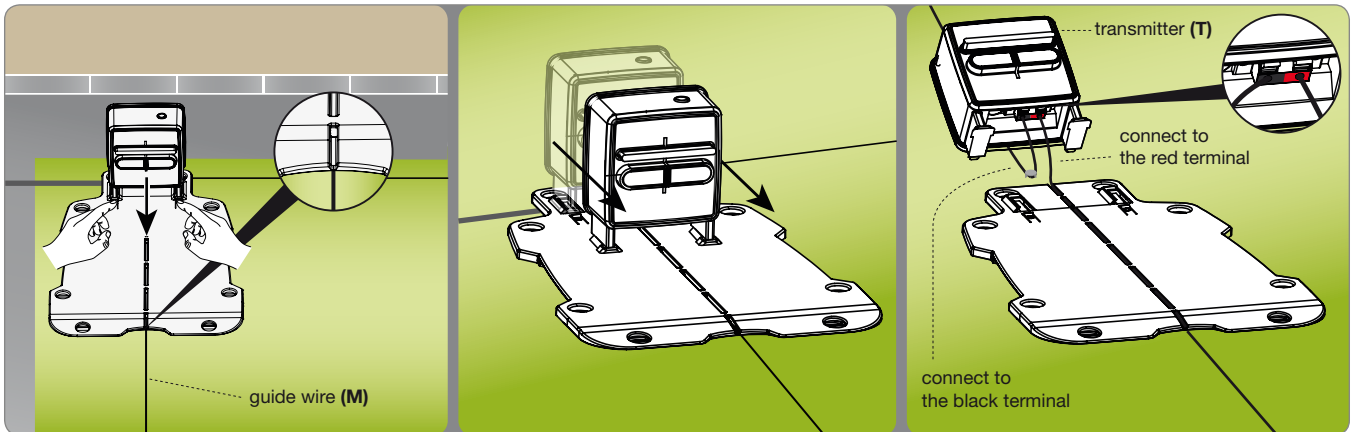

4. Fasten the charging station (N) to the ground with the pegs (P). If necessary, secure the charging station with screw anchors (Q).

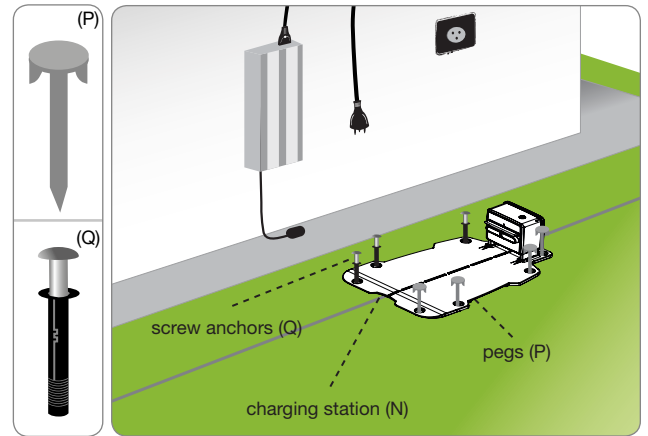

5. Install the power supply unit (A).
6. Connect the power cord (E) of the charging station (N) to the power supply unit (A).
7. Connect the plug of the power supply unit (A) to the electrical outlet.
8. If the LED of the transmitter flashes, the connection is correct. Otherwise, find the anomaly (see "Troubleshooting Guide").
9. Replace the protection (L).

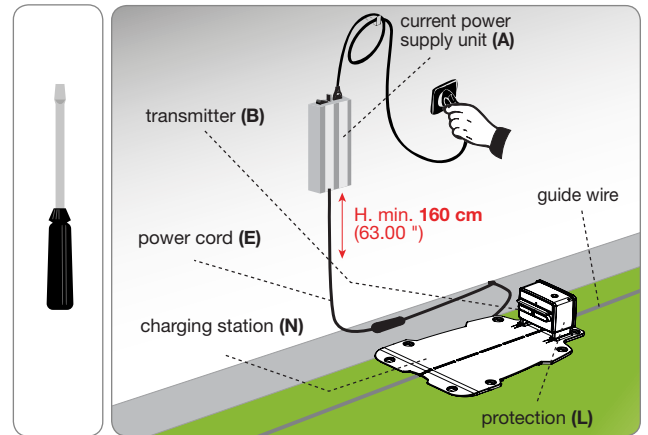

Marking the boundary of the work area

Check the entire lawn surface and assess whether it is necessary to divide it into separate work areas as per the rules described here below. Before installing the guide wire, check the entire path to make this procedure easier. The illustration shows a lawn with the track for installation of the guide wire.

During installation, identify any secondary areas. A secondary area is part of a lawn connected to the primary lawn with a passage that is difficult to reach by the robot's normal movement. The area must be reachable without any rises or drops greater than those allowed. Whether a zone is to be defined a "secondary area" also depends on the size of the primary area. The larger the primary area, the harder it will be to reach narrow passages. More generally, a passage narrower than 200 cm (78.74 ") is considered a secondary area. The number of secondary areas managed depends on the characteristics of the model (See "Technical Specifications").

The minimum clearance allowed shall be **150 cm** (59.05 ") from edge to edge. If there are objects, no-grass areas or gullies on the sides of the passage. If there are objects, no-grass areas or gullies on the sides of the passage, the minimum safety distance from them must also be considered. Therefore, with the minimum safety distance from them considered, clearance shall be a total of **200 cm** (78.74 ").

If this passage is very long, the width should be more than **150 cm** (59.05 ") from edge to edge.

During programming, it is necessary to configure the size of the areas and the quickest direction to reach them (clockwise or counter-clockwise), as well as the number of meters of wire needed to reach the secondary area.

In the event that the minimum requirements described above are not met and therefore there is the presence of a zone separated by a step, a difference in level beyond the robot's features or a passageway (corridor) less than **150 cm** (59.05 ") wide from edge to edge (aisle), the lawn area is to be considered a "Closed Area".

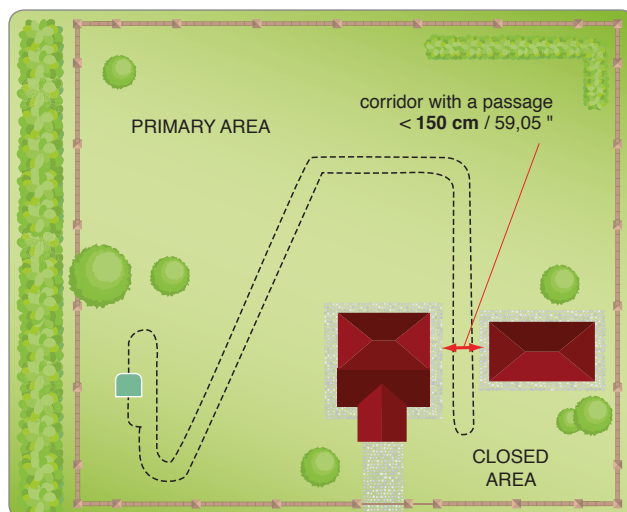
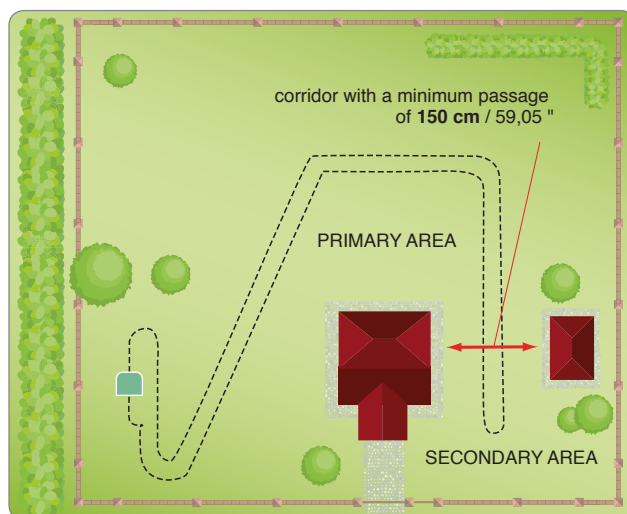
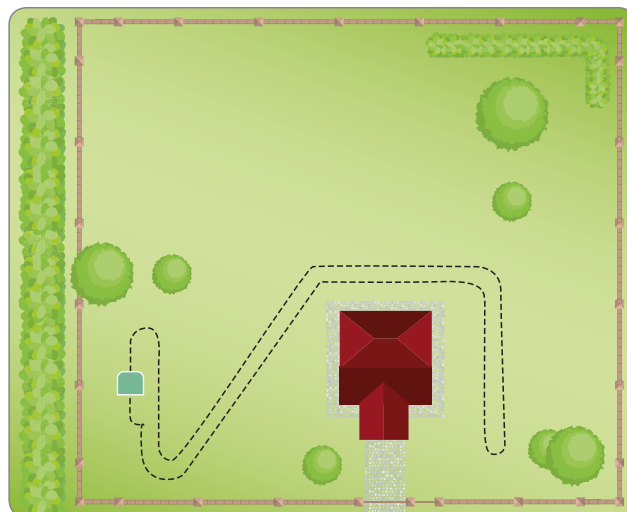

In case of metal flooring, metal manhole covers, a shower deck, or any electrical wiring, place the guide wire at least 100 cm (39,37") away from these obstacles to prevent robot malfunction and disturbance on the perimeter wire and disturbances on the guide wire.



Important

The illustration shows an example of items inside the work area and the distances that must be maintained when routing the guide wire. Observe distances from all iron or other metal elements (manholes, electrical connections, etc.) to avoid interference to the guide wire signal.

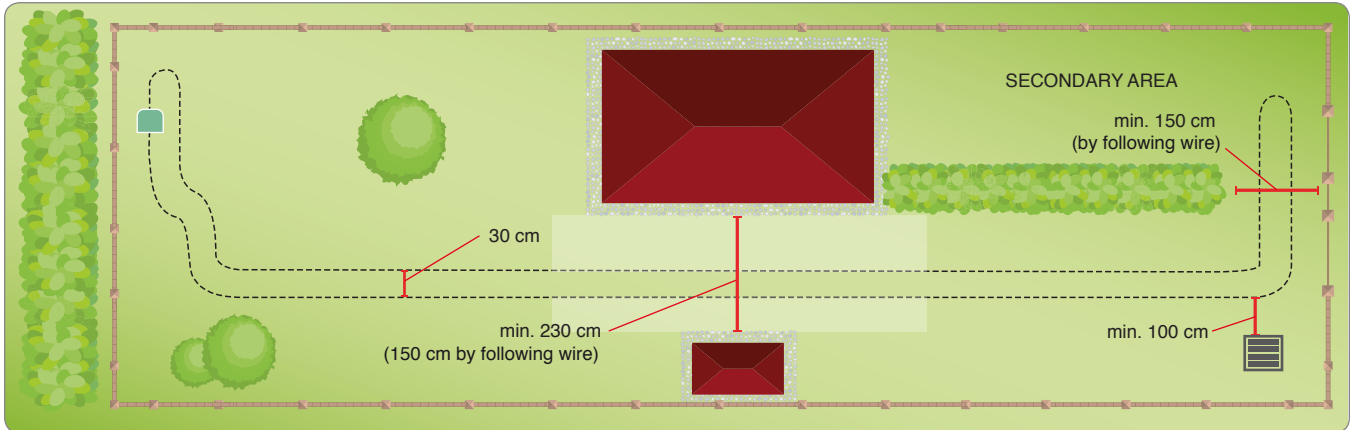

Important

Carefully follow the distances and slopes specified in the booklet to guarantee excellent installation and proper functioning of the robot. Increase the distance by at least 30 cm (11.81 ") in the presence of slopes or slippery ground.

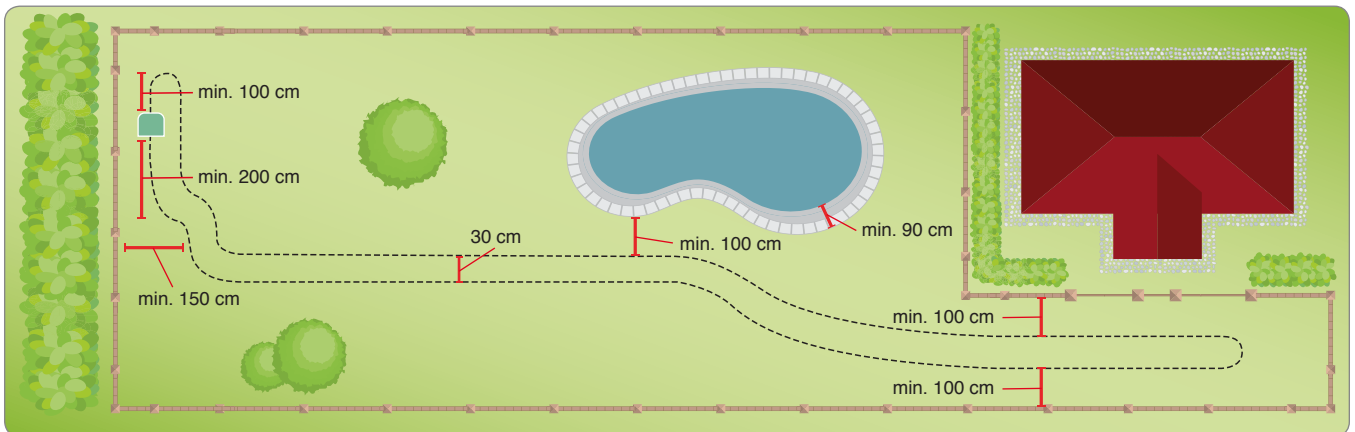

If there is a pool, pond, ravine, ditch, steps or public roads not protected by an easily crossable fence or wall inside or outside the work area, install the guide wire at least 90 cm (35.43 inches) from the edge.

If there are obstacles inside the work area that are bump resistant, such as trees, bushes or poles that do not have sharp corners, there is no need to mark them out. The robot detects the obstacle and changes direction.

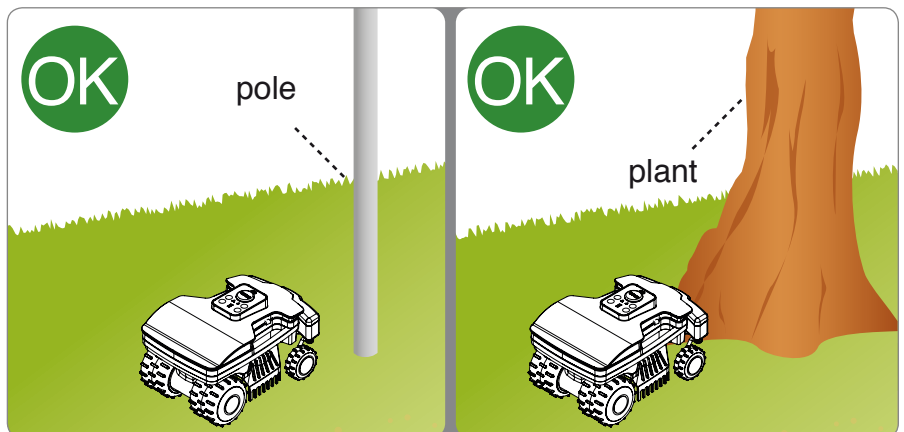

INSTALLATION OF GUIDE WIRE

The guide wire can be buried or laid on the ground. If you have a wire layer machine, it is better to bury the wire for greater protection.

Otherwise, install the wire on the ground with the pegs provided as described below.



Important

Start laying the wire from the area where the charging station is installed, leaving a couple of extra meters so that it can be cut down to size when connecting to the power unit during the final phase.

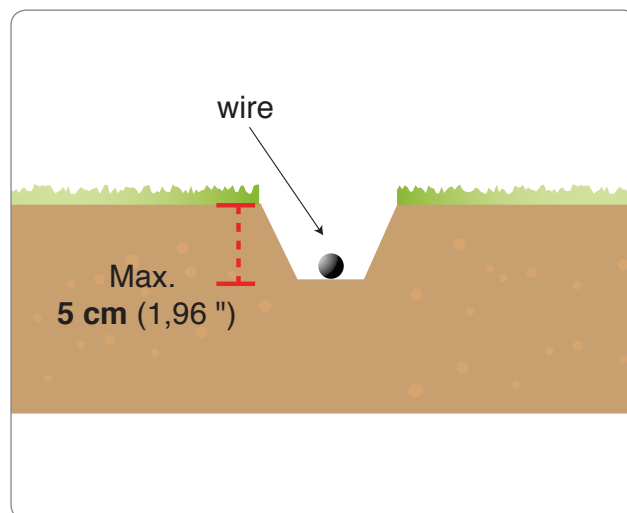

Ground wire

Cut the grass as low as possible with a grass trimmer or brushcutter along the entire path where the cable will be laid. This will make it easier to lay the cable in contact with the ground and reduce the risk of the robot damaging the insulation.

1. Position the wire in a clockwise direction along the entire path and secure it with the pegs supplied, making sure there is a maximum distance of around 100 cm (39.37 inches) between each peg. The wire must be in contact with the ground to prevent it from being damaged by the robot before the grass covers it.
 - When laying the wire, observe the clockwise direction
 - In curved sections, secure the wire so that it is not twisted, but curves nicely (radius of 20 cm).

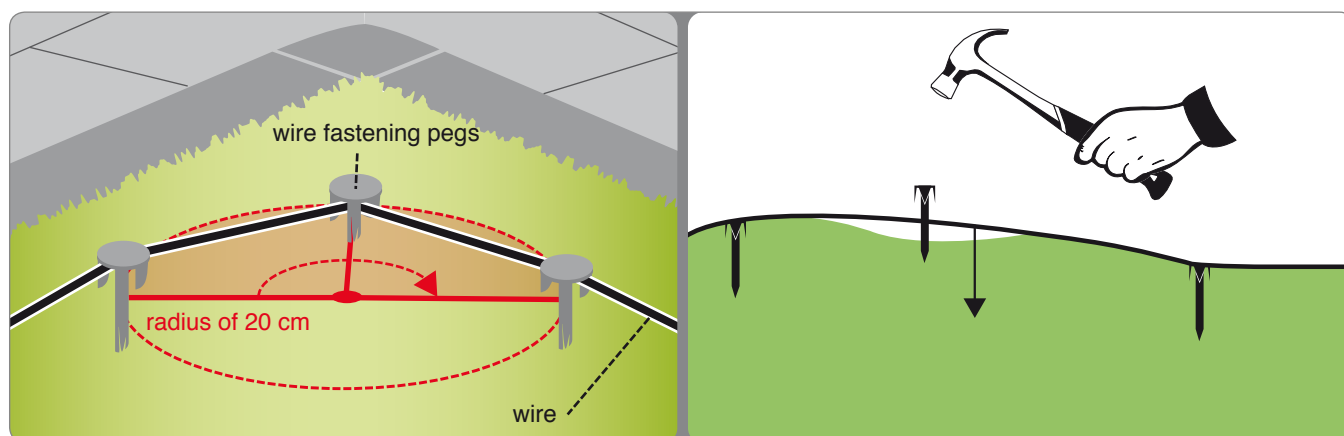
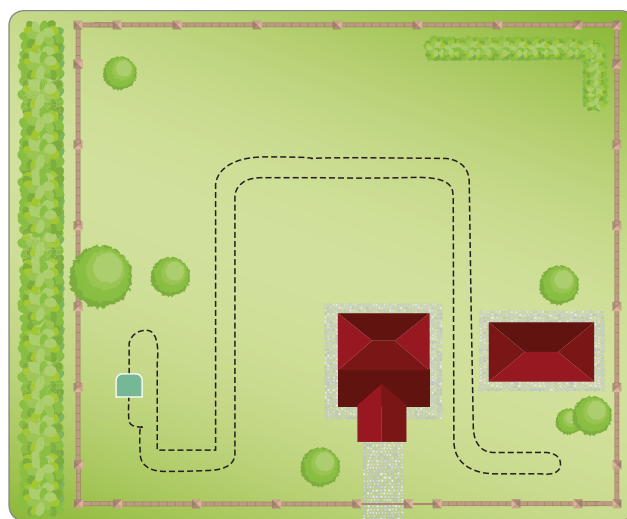

Buried wire

1. Dig an even furrow in the ground (approximately 2-3 cm or 0.787-1.181 ").
2. Position the wire in a clockwise direction along the track at a depth of a couple of centimetres. Do not bury the wire deeper than 5 cm, so as not to reduce the quality and intensity of the signal picked up by the robot.
3. During the laying of the wire, it may be necessary to secure it in some points with the pegs provided in order to hold it in place when covering with the ground.
4. Cover all the wire with soil and make sure it remains taut in the ground.

Joining of the wire

Use an original joint if another wire is needed to complete the installation.

Insert each end of the wire in the joint, making sure the wires are fully inserted so that the ends are visible on each side. Press the button on the upper side all the way down using a pair of pliers.



Important

- For a safe and secure electrical connection, only use original joints.
- Do not use insulating tape or other types of joints that do not provide proper isolation (lugs, terminals, etc.). After some time, soil moisture causes oxidation and interruption of the perimeter wire.

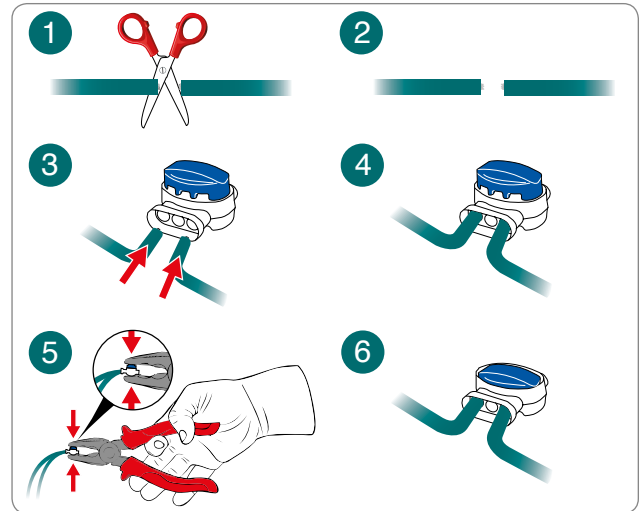

EN

BATTERY CHARGING ON FIRST USE

1. Place the robot inside the charging station.
2. Press the ON/OFF key and wait a few seconds for the robot to turn on completely.
3. The battery LED turns orange and remains fixed for a few seconds during recognition of the charging station.
4. Make sure the AUTO LED is off, if necessary press the AUTO key to turn it off.
5. At the end of charging, the robot can be used or programmed for initial start-up (see "Programming Mode").



Important

On first use, always charge the batteries for at least 4 hours.

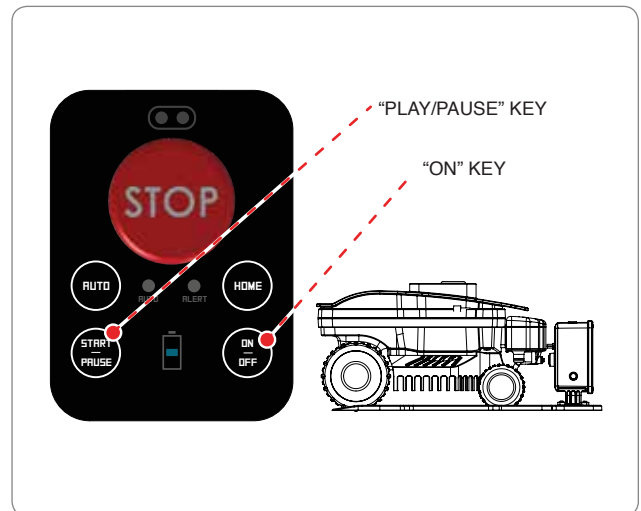



Important

- When using the robot for the first time, carefully read the entire manual and be sure to fully understand it, especially the safety recommendations.
- Only use the robot for its intended purpose as described by the Manufacturer and do not tamper with any device to obtain different operating performances.
- Do not use the robot and its peripheral units in bad weather conditions, especially when there is a risk of lightning.

DESCRIPTION OF CONTROL PANEL AND MENU OVERVIEW

The illustration shows the location and function of the controls on the machine.



STOP.

Press to stop the robotic mower safely. Only use in case of imminent danger and to perform maintenance on the robot.

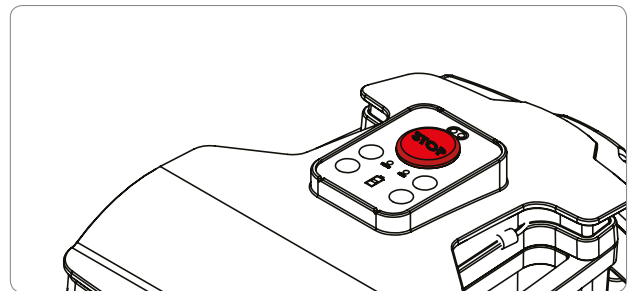

Press to turn the robot on and off.



Press to enable or disable automatic operation. When in automatic mode, the robot is programmed to work according to the program described in the following pages.



Off: Manual operation.
Fixed on: Automatic operation.



Battery charge level.



Operating errors. Refer to the chapter "TROUBLESHOOTING"



Robot in charging station (AUTO LED off)



Press to start a manual work cycle. If the battery is sufficiently charged and the AUTO LED is off, the robot starts a work cycle. When the work cycle is completed, it goes back to the charging station.

Robot in the garden



When the robot is moving, this suspends the mowing operation and places the robot in stand-by mode.

With the robot in Stand-by, this allows resuming the mowing operation.



Returns to the charging station and resumes automatic or manual operations depending on the status of the "AUTO" LED.

ACTUATION WITH THE CHARGING STATION KIT

The set up procedure is performed when the robot is started for the first time and after a long period of inactivity.

- Check that the height of the lawn surface to be cut is compatible with the proper functioning of the robot (see “Technical Specifications”).
- Adjust the cutting height as desired (see “Adjustment of Cutting Height”).
- Make sure the work area has been correctly marked and that there are no impediments to the regular functioning of the robot as described in the section “Preparation and Marking of Boundaries of the Work Areas” and following sections.
- Make sure there are no large puddles in the garden due to heavy rain.
- Place the robot inside the charging station.
- Press the ON/OFF key and wait a few seconds for the robot to turn on completely.
- The battery LED turns orange and remains fixed for a few seconds as it recognises the charging station.
- In case of first installation of the Automatic Charging Station Kit, activate the automatic operation of the robot using the wizard via APP.
- The robot is ready for use. Press the “AUTO” key to set automatic or manual operation.

Operation of the robot in manual mode with “AUTO LED off”

- When the battery is fully charged, press the START/PAUSE key to start the work cycle. When the battery capacity is exhausted, the robot returns to the charging station.
- If the garden has not been completely mowed, wait until the battery is fully charged and then start a new work cycle.
- For a better result, it is recommended to use the robot at least on every other day.
- To change the default settings of some robot functions, simply download the free application for smartphones; refer to section “ACCESS TO MENU VIA APP”

Operation of the robot in automatic mode with “AUTO LED on”

- Thanks to the automatic mode the robot is programmed to work every day of the week. Through the mobile application you can check the default time set.
- The number of work cycles is managed automatically by the robot based on the battery capacity. In automatic mode, the robot exits the charging station to perform the work cycle and returns to recharge itself, and if necessary, to resume working again.
- To change the default settings of the working time and other functions, simply download the free application for smartphones, refer to paragraph “ACCESS TO MENU VIA THE APP”.



USE OF THE ROBOT IN CLOSED AREAS WITH NO CHARGING STATION

Starting the robot in "enclosed area" mode should be done to mow enclosed areas, that the robot cannot reach by following the guide wire. Check that the work area is appropriate as described in the chapter "PREPARATION AND DELIMITATION OF WORK AREAS".



Danger - Attention

Safely stop the robot (see "Robot Safety Stop") and carry it using the handle provided. Do not grab the robot by the body and always use the handle provided.

1. Position the robot inside the work area at least 100 cm (39.37 inches) away from any obstacles
2. Press the ON/OFF button and wait a few seconds for the robot to turn on completely.
3. Connect to the robot using the APP on your smartphone and select the button 
4. Select the "closed area" key. 
5. Set the time for the end of the working cycle, and select "OK".

At the end of the working cycle, stop the robot in safe conditions (see "Robot Safety Stop") and carry it back to the area where the charging station is located.

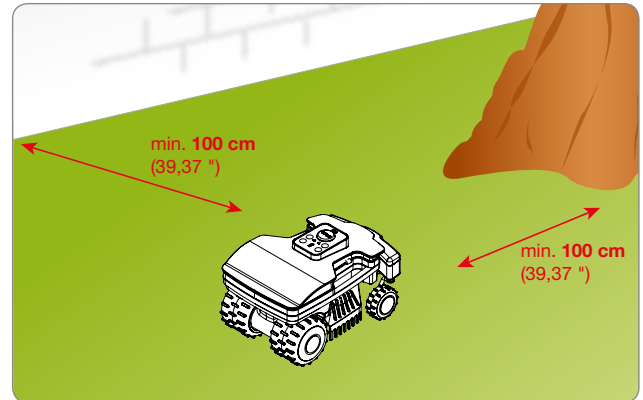

Restore the normal functioning of the robot as described in chapter "INITIAL START UP"

ACCESS TO THE MENU VIA APP

The robot has a built-in Bluetooth device that allows it to be programmed and controlled using a smartphone.

Download the Android and iOS app for your smartphone from the product's website. Start the application and follow the wizard to pair the Robot to your device.

The factory set PIN is "0000." Change the PIN as soon as possible to make the robot safe.

The application allows you to:

- Change the automatic standard working time.
- Set the operation of the rain sensor.
- Set the departure points to optimally manage the secondary area.
- Change the password.
- Send the Start / Pause / Home command.
- Guide the robot during the cutting.
- Display the status, alarms and any errors of the robot.

SETTING THE USER MENU VIA THE MOBILE APPLICATION

Start the application from your smartphone and access the robot programming menu via the "Setup" function.

Follow the introduction containing a summary of the programming functions available. Details of each function are found in the pages following the flow diagram. The functions marked with (*) are only available on some models. See the "Technical Specifications" table.

MENU SETTINGS - PROGRAMMING MODE

Start the application from your smartphone and access the robot programming menu via the “SETTINGS” function.

Follow the introduction with a summary of the programming functions available. Details of each function are found in the pages following the flow diagram. The functions marked with (*) are only available on some models. See the “Technical Specifications” table.

EN

Date and time settings



This allows you to set the date and time of the robot. These are normally set automatically when you connect to the robot.

Robot settings



This allows you to access all the settings relating to the work of the robot, such as the time of the weekly work cycle and the return to the charging station.

Profile settings

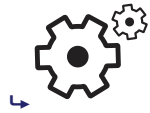

Up to 3 different working profiles can be set to meet specific mowing needs or to leave your garden free of the robot.

Weekly schedule

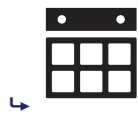

This allows you to select the times of each working cycle (up to a maximum of 4) for each day of the week, the areas to be mowed and the edge of the lawn.

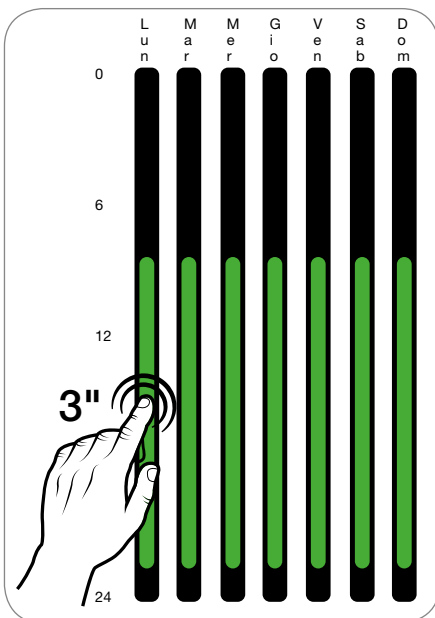

The settings for a single day can be quickly copied to all the other days in the week.

Simply press and hold on the set times for a specific day (green bar in the image on the left), a screen will appear where you can choose the other days of the week on which to apply the same times.

Recommended working hours by model and garden size

Model	m ² (ft ²)	T1	T2	T3
B015DEZ	800 (8611')	09:00 18:30		
B020DEZ	1000 (10763")	09:00 20:00		

Charge settings

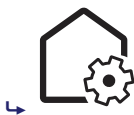

Sets the distance between the robot and guide wire during re-entry according to the set working areas.

Rain sensor settings



Enables or disables the rain sensor. You can also set a delayed start from the station if rain is detected.

Garden settings



The settings for each single work area can be accessed and managed by the robot; the available settings are:

- *Size*: approximate size of the working area
- *Distance*: distance the robot must travel to reach the area
- *Direction*: clockwise or counter-clockwise direction to reach the specific area
- *Distance from wire*: Distance of the robot from the guide wire when it is approaching the secondary area
- *Eco Mode*: If activated, the robot reduces the working time if it detects that the lawn has already been mowed.

Installation settings



Allows you to modify the following installation parameters:

- *Wire exit*: sets the exit distance of the robot from the guide wire.
- *Air Marker*: changes the distance at which the robot recognises the signal from the charging station
- *Docking Shift*: sets an offset on the guide wire in order to better centre the robot when it is returning to the charging station.

Language options



Allows you to change the robot language, date, time and distance format.

Safety



Allows you to change the start-up password of the robot. This combination is also used when pairing a new smartphone to the robot.

Password change



Allows you to change the start-up password of the robot. This combination is also used when pairing a new smartphone to the robot.

Keyboard lock



By enabling the lock function, it will not be possible to give commands to the robot using the keyboard; to start or send the robot to be recharged, use the relevant command directly from the app on the phone.

Sound settings



Allows turning the robot's sound alerts on and off.

Reset



Resets all settings to factory defaults.

CONFIGURING THE “CONNECT MODULE”

The Connect Module inside the robot allows you to connect to the GSM and GPS networks through the relative antenna, so that you can check the status of the robot remotely. It also allows you to give certain commands or to see the robot's trajectory on the map.

Depending on the model and configuration of the robot chosen, the Connect Module can be supplied as an accessory or purchased separately. Below are the instructions on how to configure and activate the Connect Module.

Robot equipped with Connect Module

- Download the application for your Android or iOS smartphone from the product's website
- Once open, add the robot by clicking on the “+” key
- After pairing the device, you may be asked to update the robot software.
- After updating the software, you will be automatically asked if you want to configure the Connect Module; proceed with the configuration
- When you have finished registering the device to the Connect Module, the Geofence configuration screen will appear; choose the desired settings
- The Connect Module has been correctly configured

Connect Module as an optional accessory

- Download the application for your Android or iOS smartphone from the product's website
- Once open, add the robot by clicking on the “+” key
- On the robot screen, click the Settings menu at the top
- Select “Configure Connect Module” to start the robot's registration procedure on your smartphone
- At the end of the registration, you will be asked to configure the Geofence function; choose the desired settings
- The Connect Module has been correctly configured

PROLONGED INACTIVITY AND RESTARTING

After a long period of inactivity of the robot and before the mowing season, it is necessary to perform a series of operations to guarantee the correct functioning at the time of reuse.

1. Fully charge the battery before winter storage. Recharge the battery at least once every five months.
2. Have the routine maintenance performed by an authorised dealer. This is essential for keeping the robot in good condition. The assistance service usually includes the following operations:
 - total cleaning of the robot, the cutting blade and all the other moving parts;
 - cleaning of the inside of the robot;
 - checking of robot functioning;
 - Check and, if necessary, replace worn components (for example the cutting blade);
 - checking of the battery capacity;
 - if necessary, the dealer may also load new software.
3. Thoroughly clean the robot and the charging station if present (see "Robot cleaning").
4. Check any worn or damaged components such as the cutting blade and evaluate their replacement.
5. Store the robot in a protected and dry place with an ambient temperature between 10° and 20° C, out of reach of foreign elements (children, animals, other foreign objects, etc.). Store the robot at a temperature below 20°C in order to reduce the automatic discharge of the batteries.
6. Disconnect the power plug (A) from the electrical outlet.
7. If present, cover the charging station to prevent material from getting inside (leaves, paper, etc.) and to preserve the contact plates.

Restarting

Follow these procedures before restarting the robot after a long period of inactivity:

1. Connect the plug of the power supply unit to the electrical outlet.
2. Reactivate the main electrical power supply.
3. Recharge the batteries of the robot for at least 4 hours.
4. Once the recharging has been completed, operate the robot normally.

Actuation with the charging station kit

before restarting the robot after a long period of inactivity, proceed as follows:

1. connect the power plug (A) to the electrical outlet;
2. reconnect the main electrical power supply;
3. position the robot inside the charging station;
4. Press the ON/OFF key and wait a few seconds for the robot to turn on completely.
5. The battery LED turns orange and remains fixed for a few seconds during recognition of the charging station.
6. the robot is now ready to be used (see "Programming Mode").

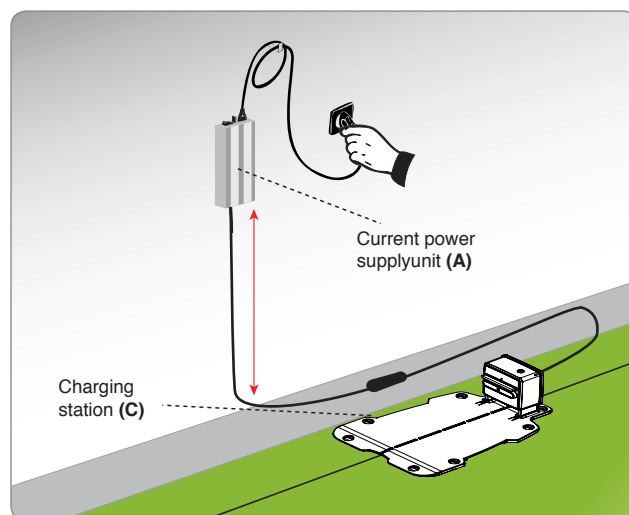



Danger - Attention

Do not recharge the robot in explosive and flammable environments.

1. Supply electricity to the charging station and make sure the plates are clean.
2. Position the robot inside the charging station.
3. Press the ON/OFF key and wait a few seconds for the robot to turn on completely.
4. The battery LED turns orange and remains fixed for a few seconds during recognition of the charging station.
5. Make sure the AUTO LED is off, if necessary press the AUTO key to turn it off.
6. At the end of the charging cycle (approx. 6 hours), press the "OFF" key (C).
7. Store the robot in a protected and dry place with an ambient temperature between 10° and 20° C, difficult to reach by children, animals, other foreign objects, etc.

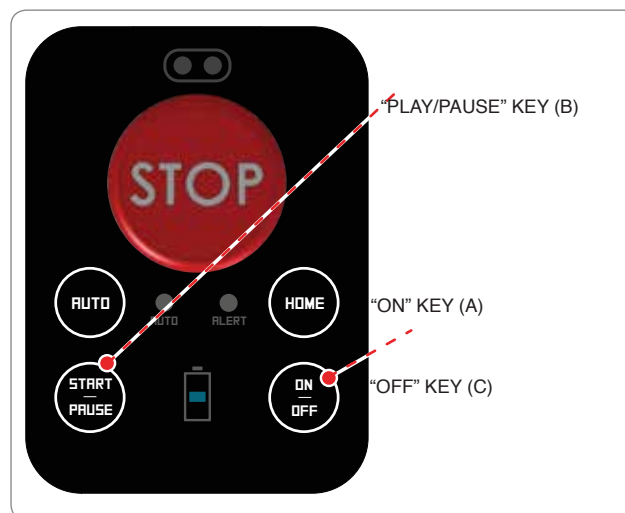

OPERATING TIPS

Below are some useful operating tips to follow when using the robot:

- even after being suitably informed on the use of the robot, it is always a good idea to simulate some test manoeuvres on first use to identify the commands and main functions;
- check and secure the fastening screws of the main components;
- mow the lawn frequently to avoid excessive growth of the grass;
- do not use the robot to mow grass which is 1 cm (0.40 ") higher than the cutting blade. In case of high grass, lift the cutting blade and then lower it gradually on the following days;
- if the lawn is equipped with an automatic sprinkler system, program the robot to return to the charging system at least one hour before the sprinklers are turned on;
- check the slope of the ground and make sure the maximum values allowed are not exceeded in order to prevent damage to the robot and the sprinklers;
- it is recommended to program the robot so that it does not work more than is necessary, also taking into consideration the different growth rates of the grass in different seasons, so as not to subject it to unnecessary deterioration and reduction of the battery life;
- when using the robot, make sure the work area is clear of people (in particular, children, the elderly or disabled people) and pets in order to prevent safety risks. To minimise the chance of injury, program the robot so that it operates at suitable times of the day.

The manufacturer does not guarantee complete compatibility between the robotic mower and other types of wireless systems, such as remote controls, radio transmitters, acoustic aids, underground electric fences for animals or the like.

ROUTINE MAINTENANCE

MAINTENANCE RECOMMENDATIONS



Important

During maintenance, use personal protection equipment indicated by the Manufacturer, especially when working on the blade. Before carrying out any type of maintenance, make sure the robot is turned off (see "Robot Safety Stop").

SCHEDULED MAINTENANCE TABLE

Frequency	Part	Type of maintenance	Reference
Weekly	Blade	Clean and check the efficiency of the blade. If the blade is bent or very worn, replace it	See "Robot Cleaning" See "Blade Replacement"
	Battery charging knobs	Clean and remove any rust	See "Robot Cleaning"
	Contact plates	Clean and remove any rust	See "Robot Cleaning"
	Rain sensor	Clean and remove any rust	See "Robot Cleaning"
Monthly	Robot	Clean the robot	See "Robot Cleaning"
Once a year and at the end of the mowing season	Robot	Have the robot serviced at an authorised service centre	See "Prolonged inactivity and restarting"

ROBOT CLEANING

1. Stop the robot safely (see “Robot Safety Stop”).



Warning – Caution

Use protective gloves to prevent cutting your hands.

2. Clean all the outside surfaces of the robot with a sponge soaked in warm water and a mild detergent. Squeeze well to remove any excess water before use.



Warning – Caution

The use of too much water may cause water to penetrate into the device which could damage the electrical parts.

3. Do not use solvents or benzene so as not to damage the painted surfaces and plastic components.
4. Do not wash the inside parts of the robot and do not use jets of pressurised water so as not to damage the electric and electronic parts.



Warning – Caution

In order to avoid irreversible damage to the electric and electronic components, do not immerse the robot, partially or completely, in water because it is not watertight.

5. Check the lower part of the robot (cutting blade area, and wheels), use a brush suitable to remove deposits and/or residues that may impede the proper functioning of the robot.
6. Remove any grass and leaves from the gripping areas of the robot.
7. Clean the knobs of the battery charger (A), the contact plates (B) and remove any deposits or residuals caused by electric contacts with a dry cloth and, if necessary, with fine sandpaper.
8. Clean the rain sensor (C) and remove any dirt or rust.
9. Clean the inside of the charging station to remove any accumulated residuals.

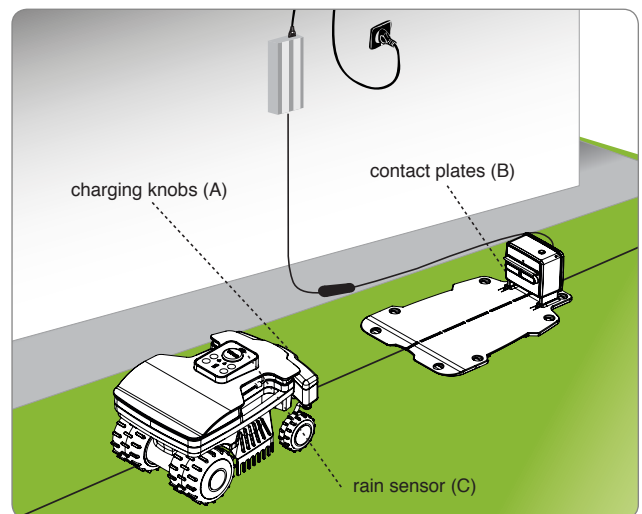

TROUBLESHOOTING GUIDE

EN

The information below is designed to help identify and correct any faults and/or malfunctions which may occur during operation. Some faults can be fixed by the user, while others require specific technical skills or special expertise and therefore must only be fixed by qualified personnel with certified experience in the specific field of intervention. When the robot is in an error state and the ALERT light is on or flashing, connect to the robot using the APP on your smartphone to see what the problem is.



Warning – Caution

Safely stop the robot (see “Robot Safety Stop”) in case it is necessary to check the robot, in order to avoid danger of accidental blade starting.

Problem	Cause	Remedies
Abnormal vibrations The robot is very noisy	Cutting blade damaged	Replace the blade with a new one (see “Blade Replacement”)
	Cutting blade clogged by residuals (tape, cords, plastic fragments, etc.)	Safely stop the robot (see “Robot Safety Stop”). Unclog the blade Warning – Caution Use protective gloves to prevent injuries to your hands
	The robot was started in the presence of obstacles (fallen branches, forgotten objects, etc.)	Stop the robot safely (see “Robot Safety Stop”) Remove the obstacle and restart the robot (see “Start up - Automatic mode”)
	Electric motor failure	Have the motor replaced or repaired by your nearest authorised service centre
	Grass too high	Increase the cutting height (see “Adjustment of cutting height”) Carry out a preliminary cutting of the area with a normal lawnmower
The robot does not position itself correctly inside the charging station	Incorrect positioning of the guide wire or power cord of the charging station	Check the connection of the charging station (see “Installation of charging station and power supply unit”)
	Collapsing of ground next to the charging station	Position the charging station on a flat and stable surface (see “Planning of system installation”)
The robot works at the wrong time	Clock was set incorrectly	Reset the clock of the robot (see “Programming Mode”)
	Working time was set incorrectly	Reset the working time (see “Programming Mode”)

Problem	Cause	Remedies
The work area is not completely mowed	Not enough work hours	Extend the working time (see “Programming Mode”)
	Cutting blade clogged with deposits and/or residuals	Stop the robot safely (see “Robot Safety Stop”)  Warning – Caution Use protective gloves to prevent injuries to your hands. Clean the cutting blade
	Cutting blade worn out	Replace the blade with an original spare part (see “Blade replacement”)
	Work area too big compared to the actual capacity of the robot	Adjust the work area (see “Technical specifications”)
	The batteries are about to run out.	Replace the batteries with original spare parts (see “Battery replacement”)
	The batteries do not charge completely	Clean and remove any rust from the contact points of the batteries (see “Robot Cleaning”).
Secondary area not completely mowed	Programming error	Correctly program the secondary area (see “Programming Mode”)
 Slow orange flashing light	Date and time not set	Connect to the robot using the APP on your smartphone to update the date and time
	Cutting blade damaged	Replace the blade with a new one (see “Blade Replacement”).
	Cutting blade clogged by residuals (tape, cords, plastic fragments, etc.).	Safely stop the robot (see “Robot Safety Stop”).  Danger - Attention Use protective gloves to prevent cutting your hands. Unclog the blade.
	Grass too high	Increase the cutting height (see “Adjustment of cutting height”)
	The robot is lifted from the ground	Check that the robot is not blocked or obstructed by any object. Clean and remove any grass residues from under the body that may block the sensors.
 Orange double flashing	Error NO GRASS	Check that there is sufficient grass in the areawhere the robot stops. Move the robot to a different area of the lawn.
 Fast orange flashing light	After pressing the OFF key, the LED flashes quickly	Connect to the robot using the APP on your smartphone to entire the robot’s PIN
	The guide wire is not connected properly (broken cable, no electrical connection, etc.)	Check the functioning of the electrical power supply, the correct connection of the power supply unit and charging station (see “Installation of charging station and power supply unit”).
 Fixed orange light	Irrecoverable error.	Turn the robot off and on. If the problem persists, contact your nearest authorised service centre.

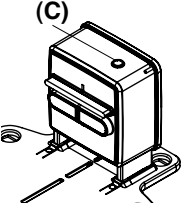
Problem		Cause	Remedies
 (C)	The led (c) does not turn on	No power supply	Make sure the power supply unit is correctly connected to the power outlet
		Interrupted fuse	Have the fuse replaced by your nearest authorised service centre
	The transmitter LED (C) is on	Interrupted guide wire	Stop the robot safely (see “Robot Safety Stop”). Disconnect the power plug from the power supply unit. Join the wire

PART REPLACEMENT

RECOMMENDATIONS FOR REPLACING PARTS



Important

Replace and repair any parts according to the manufacturer’s instructions, or contact the service centre if these operations are not included in the manual.

BATTERY REPLACEMENT



Important

Replace the batteries at an authorised service centre.

BLADE REPLACEMENT

1. Stop the robot safely (see “Robot Safety Stop”).



Important

Use protective gloves to prevent injuries to your hands.

For replacement, use only the original blade suitable for the device.

Model: B015DEZ, B020DEZ

Cutting blade code: L20Z13600A_R

2. Turn the robot over and position it so as not to ruin the covering hood.
3. Unscrew the screws (B) to remove the blade (A).
4. Insert a new blade and fasten the screws.
5. Turn the robot back over to its operating position.

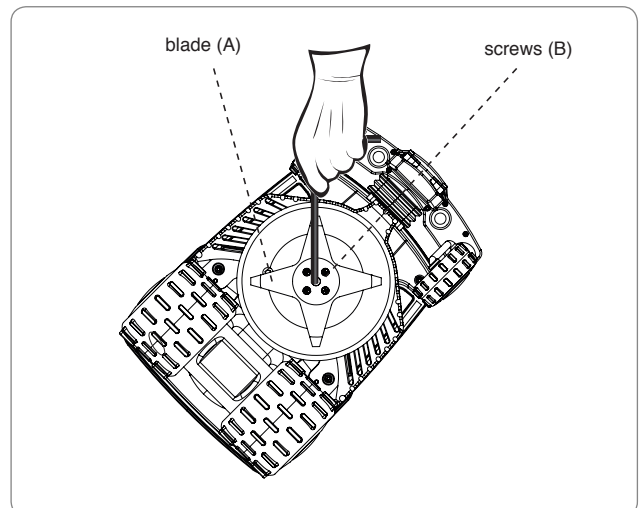

ROBOT DISPOSAL

- At the end of its useful lifespan, this product is classified as WEEE (waste electrical and electronic equipment). It must therefore not be disposed of as normal domestic waste, as mixed urban waste (undifferentiated) or as separated urban waste (differentiated).
- When it is time for disposal, the user must make sure that the product is recycled in compliance with the requirements of the local laws; in particular, electric and electronic components must be separated and sorted in authorised waste disposal centres for WEEE, or the product must be taken intact to the dealer when a new purchase is made. Abusive disposal of WEEE is punished by fines established by laws in force in the areas where said disposal occurs.
- Dangerous substances contained in electric and electronic equipment have potentially harmful effects on the environment and people's health so the user has a fundamental role in contributing to reuse, recycling and any other way of recovering WEEE.
- All parts, to be specifically separated and disposed of, are marked..



EN



Danger - Attention

WEEE - Waste Electric and Electronic Equipment (WEEE) can contain dangerous substances with potentially harmful effects on the environment and people's health. WEEE must be disposed of correctly and only in specific disposal centres.

- Packaging - Product packaging is made with recyclable materials and must be disposed of in a sustainable manner in special disposal containers or authorised waste disposal centres.
- Batteries - Old or exhausted batteries contain harmful substances for the environment and people's health so must not be disposed of as normal domestic waste. The user must dispose of batteries in a sustainable way, in specific disposal containers or in authorised waste disposal centres.



ZUCCHETTI Centro Sistemi S.p.A. Via Lungarno 305/A Terranuova B.ni (AR) ITALY

Declares and assumes liability that the product:

battery-powered automatic lawnmower robot, models B015DEZ, B020DEZ complies with the basic requisites for safety, health and environmental protection provided for by the following European Union directives:

Machinery directive 2006/42/EC, electromagnetic compatibility directive 2014/30/EU, Radio (RED) directive 2014/53/EU, RoHS directive 2011/65/EU, WEEE directive 2012/19/EU, directive for noise emission in the environment 2005/88/EC;

complies with the following harmonised standards:

EN 50636-2-107:2015 + A1:2018 and EN 60335-1:2012 + AC:2014 + A11:2014 + A13:2017 (**safety**);

EN 62233:2008 (**electromagnetic fields**);

EN 55014-1:2017 (**emission**);

EN 61000-3-2:2014 and EN 61000-3-3:2013 (**emission**);

EN 55014-2:2015 (**immunity**);

EN 50419:2006 (**WEEE – Equipment marking**)

ETSI EN 301 489-1 V2.1.1 (**Electromagnetic compatibility**)

ETSI EN 301 489-17 V3.1.1 (**Electromagnetic compatibility**)

ETSI EN 300 328 V2.1.1 (**Radio Spectrum Efficiency**)

ETSI EN 303 447 V1.1.1 (**Radio Spectrum Efficiency**)

Models equipped with "Connect module (GPS, GPRS)":

ETSI EN 301 511 V12.5.1 (**Radio Spectrum Efficiency**)

also declares that, pursuant to directive 2005/88/EC, the LWA sound power level, out of a significant sample is 59 dB ± 2.0 dB (weighted on A curve and referred to 1 pW), that the guaranteed LWA sound power level is less than 61 dB (weighted on A curve and referred to 1 pW) and that the technical folders in compliance with directives 2005/88/EC and 2006/42/EC are available c/o Zucchetti Centro Sistemi S.p.A. via Lungarno 305/a, Terranuova B.ni (ar), Italy.

Terranuova B.ni 05/04/2021

Bernini Fabrizio
(CEO)

Zucchetti Centro Sistemi S.p.A (ZCS) ensures application of all the requirements of European Directive 1999/44/CE. In particular, the warranty covers any material or manufacturing defects for a period of 2 (two) years from the original date of purchase.

ZCS does not warrant uninterrupted or error-free operation of the product, nor shall it be liable for damage caused by the failure to follow instructions. Furthermore, this warranty does not cover aesthetic damage, such as scratches, nicks and dents; consumable materials such as batteries, unless the damage was caused by a defect in materials or workmanship; damage caused by the use of the product with accessories not manufactured or sold by ZCS; damage caused by accidents, abuse, misuse, floods, fire or other natural events or external causes; damage caused by operations performed by service providers not authorised by ZCS; or damage to a product that has been modified or altered without the written permission of ZCS.

ZCS shall have the exclusive right to repair or replace (with a new or refurbished product) the product or components or to offer, at its sole discretion, full refund or the purchase price. When a refund is given, the product for which you received the refund must be returned to ZCS and it becomes the property of ZCS.

During the warranty period, ZCS shall, at its sole discretion, see to repairing or replacing any parts that fail in normal use. The repair or replacement may include the use of newly manufactured or refurbished used parts as ZCS sees fit. ZCS also has the right to use replacement units, parts or components of similar value and design. The cost of parts or labour for repairs or replacements will not be charged to the customer, who instead will be charged for the shipping costs. When replacing a product or part, any replacement element becomes the property of the user and the replaced part becomes the property of ZCS, depending on the case.

This warranty does not affect the legal rights of customers under applicable state or national laws, except for charges established by these laws to be borne by the customer to enforce this warranty.

The warranty is limited to the country of purchase and is enforced at the retail outlet where the robot was purchased or at your nearest service centre. The faulty robot must be returned in person to your vendor or to your nearest service centre. In the case of delivery by courier, to be paid by the purchaser, the robot must be packed in its original packaging and accompanied by a copy of the invoice or purchase receipt, including the date of purchase, serial number and description of the problem.

CONDITIONS AND LIMITATIONS

- For the application methods of this warranty and for any information, contact your dealer.
- This warranty is valid only if:
 - the faulty product is brought back with the original legible invoice or purchase receipt showing the purchase date and name of the dealer.
- This warranty is void if:
 - the product has not been used according to the instructions of use and maintenance;
 - the installation or use did not comply with the instructions of use;
 - the serial number has been cancelled or made illegible;
 - any unauthorised peripheral device has been used or the product has been modified;
 - unoriginal spare parts or accessories have been used;
 - a part or an accessory has been tampered with;
 - maintenance has been performed by the customer or by unauthorised third parties;
 - the robot, power supply unit, charging station or accessories has faults caused by atmospheric agents such as lightning, avalanches, landslides, power surges, storms, floods, natural disasters, etc.
- Excluded from the warranty and limitations:
 - the warranty does not cover parts subject to wear following use, such as brushes, cutting blades, guide wire, pegs, belts, wheels, blades, cables and connection cords;
 - external parts and plastic supports that do not present manufacturing defects. Discoloration of plastic due to natural reasons or chemicals;
 - the battery warranty is limited only to manufacturing defects in the first six months of life;
 - the motors have a warranty of 2 years with limit at 3000 working hours.

HOW TO REQUEST WARRANTY SERVICE

To request warranty service and specific instructions on where and how to return the ZCS product for service, contact the dealer where you purchased the robot or your nearest service centre. To enforce the warranty right, the customer must present an original or a copy of the invoice or purchase receipt of the product issued by the original dealer. The limited warranty is only valid and enforceable in the country where ZCS or its authorised dealers originally sold the product.

ADDITIONAL DEFINITIONS

On-site support

- The customer is not entitled to on-site support of the product, not even during the warranty period.
- Should on-site support be necessary, the call and the hourly rate applied by the service centre will be charged to the customer.

Suggestions

- Keep the original packaging.
- Keep the invoice or purchase receipt (cause for loss of warranty).

Please note

- The customer is obliged to carefully read the instruction booklet and to follow all the information contained in it.

